

Soft-Starter

SSW900

Programming Manual

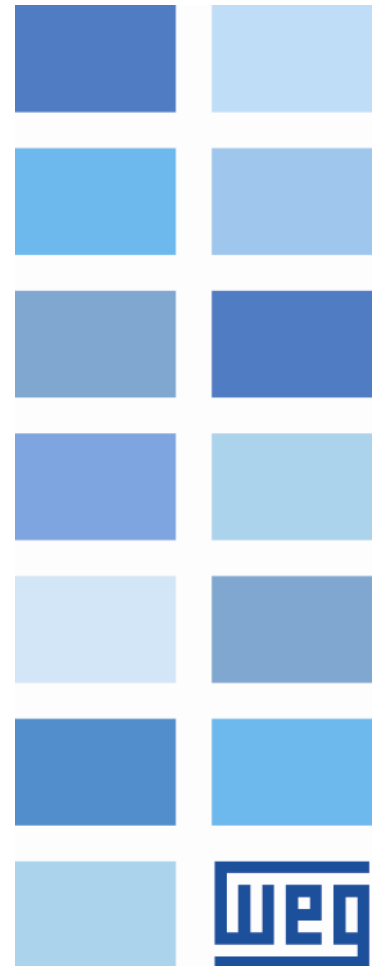



Soft-Starter Programming Manual

Series: SSW900

Software version: 1.2X

Language: English

Document: 10003989140 / 03

Build 5251

Publication Date: 01/2019

The information below describes the reviews made in this manual.

Version	Revision	Description
-	R00	First edition.
V1.0X	R01	General Revision.
V1.1X	R02	General Revision.
V1.2X	R03	General Revision.

CONTENTS

1	PARAMETER STRUCTURE	9
2	FAULTS AND ALARMS	11
3	SAFETY NOTICES	19
3.1	SAFETY NOTICES IN THIS MANUAL	19
3.2	SAFETY NOTICES ON THE PRODUCT	19
3.3	PRELIMINARY RECOMMENDATIONS	20
4	ABOUT THIS MANUAL	21
4.1	TERMINOLOGY AND DEFINITIONS	21
4.1.1	Terms and Definitions Used in the Manual	21
4.1.2	Symbols for the Parameter Properties Description	22
5	SOFTWARE VERSIONS	23
6	ABOUT THE SSW900 SOFT-STARTER	24
7	HMI	26
8	HMI OPERATION	27
8.1	MAIN SCREEN – LEVEL 0	27
8.2	MENU ACCESS MODE – MENU LEVELS	28
8.2.1	Reading Variables – Status and Diagnostics	28
8.2.2	Writing Variables - Configurations	29
8.2.3	Writing Variables – Assistant	29
8.3	HELP SOFT KEY	30
8.4	PASSWORD SETTING	30
8.5	DATE AND TIME SETTING	30
8.6	MAIN SCREEN SETTING	31
9	S STATUS	33
S1	MEASUREMENTS	33
S1.1	Current	33
S1.2	Main Line Voltage	33
S1.3	Output Voltage	34
S1.4	SCR Blocking Voltage	34
S1.5	Output Power & P.F.	34
S1.6	P.L.L.	35
S1.7	Motor Torque	36
S1.8	Control Voltage	36
S2	I/O	36
S2.1	Digital	37
S2.2	Analog Output	37
S3	SSW900	38
S3.1	SSW Status	38
S3.1.3	Status Word	38
S3.1.4	Configuration Mode	39
S3.2	Software Version	40
S3.2.2	Details	40
S3.3	SSW Model	41

S3.4 Fan Status	42
S3.5 Accessories	42
S4 TEMPERATURES	43
S4.1 SCRs Temperature	43
S4.2 Thermal Class Status	43
S4.3 Motor Temperature	43
S5 COMMUNICATIONS	44
S5.1 Status Word	44
S5.2 Command Word	45
S5.3 Value for Outputs	46
S5.3.2 Value for AO	46
S5.4 RS485 Serial	46
S5.5 Anybus-CC	47
S5.6 Configuration Mode	47
S5.7 CANopen/DeviceNet	49
S5.9 Bluetooth	50
S6 SOFTPLC	50
S6.1 SoftPLC Status	51
S6.2 Scan Cycle Time	51
S6.3 Value for Outputs	51
S6.3.2 AO Value	51
S6.4 Parameter	52
10D DIAGNOSTICS	53
D1 FAULT	53
D1.1 Actual	53
D1.2 Fault History	53
D2 ALARMS	53
D2.1 Actual	53
D2.2 Alarm History	54
D3 EVENTS	54
D4 MOTOR ON	54
D4.1 Start Current	54
D4.2 Real Start Time	55
D4.3 Current Full Voltage	55
D4.4 Main Line Voltage	55
D4.5 Main Line Frequency	56
D4.6 kWh Counter	56
D4.7 Number Start	56
D5 TEMPERATURES	56
D5.1 SCRs Maximum	56
D5.2 Motor Maximum	57
D6 HOURS CONTROL	57
D7 CHANGED PARAMETERS	57
11C CONFIGURATIONS	58
C1 STARTING AND STOPPING	58
C2 NOMINAL MOTOR DATA	69
C3 LOC/REM SELECTION	70

C4 I/O	72
C4.1 Digital Inputs	72
C4.2 Digital Outputs	76
C4.3 Analog Output	79
C5 PROTECTIONS	81
C5.1 Voltage Protections	81
C5.1.1 Motor Undervoltage	81
C5.1.2 Motor Overvoltage	82
C5.1.3 Motor Voltage Imbalance	83
C5.2 Current Protections	84
C5.2.1 Motor Undercurrent	84
C5.2.2 Motor Overcurrent	85
C5.2.3 Current Imbalance	86
C5.3 Torque Protections	87
C5.3.1 Undertorque	87
C5.3.2 Overtorque	88
C5.4 Power Protections	89
C5.4.1 Underpower	89
C5.4.2 Overpower	90
C5.5 Phase Sequence	91
C5.6 Bypass Protections	91
C5.7 Time Protections	93
C5.8 Motor Thermal Protection	95
C5.8.1 Ch1 Installed Sensor	96
C5.8.2 Ch1 Sensor Fault	96
C5.8.3 Ch1 Overtemperature	96
C5.8.4 Ch2 Installed Sensor	97
C5.8.5 Ch2 Sensor Fault	97
C5.8.6 Ch2 Overtemperature	98
C5.8.7 Ch3 Installed Sensor	99
C5.8.8 Ch3 Sensor Fault	99
C5.8.9 Ch3 Overtemperature	99
C5.8.10 Ch4 Installed Sensor	100
C5.8.11 Ch4 Sensor Fault	100
C5.8.12 Ch4 Overtemperature	101
C5.8.13 Ch5 Installed Sensor	101
C5.8.14 Ch5 Sensor Fault	102
C5.8.15 Ch5 Overtemperature	102
C5.8.16 Ch6 Installed Sensor	103
C5.8.17 Ch6 Sensor Fault	103
C5.8.18 Ch6 Overtemperature	103
C5.9 Motor Thermal Class	104
C5.9.7 Motor Data	109
C5.9.8 Thermal Image	112
C5.10 SSW Short Circuit	113
C5.11 Fault Auto-Reset	114
C6 HMI	114

C6.1 Password	115
C6.2 Language	115
C6.3 Date and Time	115
C6.4 Main Screen	116
C6.5 LCD Backlight	116
C6.6 Communication Timeout	116
C7 SPECIAL FUNCTIONS	117
C7.1 Forward/Reverse	117
C7.2 Kick Start	119
C7.3 Jog	120
C7.4 Braking	121
C8 COMMUNICATION	124
C8.1 I/O Data	125
C8.1.1 Data Read	125
C8.1.2 Data Write	126
C8.2 RS485 Serial	128
C8.2.5 Timeout	129
C8.3 Anybus-CC	130
C8.3.9 Modbus TCP Timeout	133
C8.3.10 Off Line Error	134
C8.4 CANopen/DeviceNet	135
C8.4.5 CAN Error	136
C8.6 Bluetooth	137
C9 SSW900	138
C9.1 Nominal Data	138
C9.2 Types of Connections	139
C9.3 Accessories Config.	140
C9.4 Fan Configuration	141
C10 LOAD / SAVE PARAMETERS	141
C10.1 Load / Save User	141
C10.2 Copy Function HMI	142
C10.3 Erase Diagnostics	143
C10.4 Load Factory Default	143
C10.5 Save Changed Param.	144
C11 SOFTPLC	144
C11.3 Parameter	145
12A ASSISTANT	146
A1 ORIENTED START-UP	146
13 PROGRAMMING INFORMATION AND SUGGESTIONS	147
13.1 APPLICATIONS AND PROGRAMMING	147
13.2 STARTING WITH VOLTAGE RAMP + CURRENT LIMIT (C1.1 = 1)	149
13.3 STARTING WITH CURRENT LIMIT (C1.1 = 2)	149
13.4 STARTING WITH CURRENT RAMP AND HIGHER INITIAL VALUE (C1.1 = 3)	150
13.5 STARTING WITH CURRENT RAMP AND LOWER INITIAL VALUE (C1.1 = 3)	151
13.6 STARTING WITH PUMP CONTROL (C1.1 = 4)	152
13.7 STARTING WITH TORQUE CONTROL (C1.1 = 5)	154
13.7.1 Constant Torque Loads	154

13.7.2	Loads with Higher Initial Torque	155
13.7.3	Constant Torque Loads with S Speed Curve	155
13.7.4	Quadratic Torque Loads with S Speed Curve	156
13.7.5	Quadratic Torque Loads with Linear Speed Curve	156
13.7.6	Quadratic Loads with Higher Initial Torque	157
13.7.7	Hydraulic Pump Type Loads	157
13.8	UNDER AND OVER PROTECTIONS	161
13.8.1	Undervoltage and Overvoltage Protections	161
13.8.2	Underload Protection	162
13.8.3	Overload Protection	162
13.9	Thermal Classes	163
13.9.1	How to choose the thermal class	163
13.9.2	Example of how to program the Thermal Class	164
13.9.3	Time Reduction When Changing from Cold Starting to Hot Starting	165
13.9.4	Service Factor	165

1 PARAMETER STRUCTURE

Level 1	Level 2	Level 3	Page	
S Status	S1	Measurements	<ul style="list-style-type: none"> S1.1 Current S1.2 Main Line Voltage S1.3 Output Voltage S1.4 SCR Blocking Voltage S1.5 Output Power & P.F. S1.6 P.L.L. S1.7 Motor Torque S1.8 Control Voltage 	33
	S2	I/O	<ul style="list-style-type: none"> S2.1 Digital S2.2 Analog Output 	36
	S3	SSW900	<ul style="list-style-type: none"> S3.1 SSW Status S3.2 Software Version S3.3 SSW Model S3.4 Fan Status S3.5 Accessories 	38
	S4	Temperatures	<ul style="list-style-type: none"> S4.1 SCRs Temperature S4.2 Thermal Class Status S4.3 Motor Temperature 	43
	S5	Communications	<ul style="list-style-type: none"> S5.1 Status Word S5.2 Command Word S5.3 Value for Outputs S5.4 RS485 Serial S5.5 Anybus-CC S5.6 Configuration Mode S5.7 CANopen/DeviceNet S5.9 Bluetooth 	44
	S6	SoftPLC	<ul style="list-style-type: none"> S6.1 SoftPLC Status S6.2 Scan Cycle Time S6.3 Value for Outputs S6.4 Parameter 	50
D Diagnostics	D1	Fault	<ul style="list-style-type: none"> D1.1 Actual D1.2 Fault History 	53
	D2	Alarms	<ul style="list-style-type: none"> D2.1 Actual D2.2 Alarm History 	53
	D3	Events		54
	D4	Motor On	<ul style="list-style-type: none"> D4.1 Start Current D4.2 Real Start Time D4.3 Current Full Voltage D4.4 Main Line Voltage D4.5 Main Line Frequency D4.6 kWh Counter D4.7 Number Start 	54
	D5	Temperatures	<ul style="list-style-type: none"> D5.1 SCRs Maximum D5.2 Motor Maximum 	56
	D6	Hours Control		57
	D7	Changed Parameters		57

Level 1	Level 2	Level 3	Page	
C Configurations	C1	Starting and Stopping	58	
	C2	Nominal Motor Data	69	
	C3	LOC/REM Selection	70	
	C4	I/O	72	
			C4.1 Digital Inputs	
			C4.2 Digital Outputs	
			C4.3 Analog Output	
	C5	Protections	81	
			C5.1 Voltage Protections	
			C5.2 Current Protections	
			C5.3 Torque Protections	
		C5.4 Power Protections		
		C5.5 Phase Sequence		
		C5.6 Bypass Protections		
		C5.7 Time Protections		
		C5.8 Motor Thermal Protection		
		C5.9 Motor Thermal Class		
		C5.10 SSW Short Circuit		
		C5.11 Fault Auto-Reset		
C6	HMI	114		
		C6.1 Password		
		C6.2 Language		
		C6.3 Date and Time		
		C6.4 Main Screen		
		C6.5 LCD Backlight		
		C6.6 Communication Timeout		
C7	Special Functions	117		
		C7.1 Forward/Reverse		
		C7.2 Kick Start		
		C7.3 Jog		
		C7.4 Braking		
C8	Communication	124		
		C8.1 I/O Data		
		C8.2 RS485 Serial		
		C8.3 Anybus-CC		
		C8.4 CANopen/DeviceNet		
		C8.6 Bluetooth		
C9	SSW900	138		
		C9.1 Nominal Data		
		C9.2 Types of Connections		
		C9.3 Accessories Config.		
		C9.4 Fan Configuration		
C10	Load / Save Parameters	141		
		C10.1 Load / Save User		
		C10.2 Copy Function HMI		
		C10.3 Erase Diagnostics		
		C10.4 Load Factory Default		
		C10.5 Save Changed Param.		
C11	SoftPLC	144		
		C11.3 Parameter		
A Assistant	A1 Oriented Start-up	146		

2 FAULTS AND ALARMS

Fault/Alarm	Description	Possible Causes
F001/A001: Motor Voltage Imbalance	<p>When the difference between R-S, S-V and T-S (S1.2) line voltage values (as a percentage of C2.1) is greater than the value programmed in C5.1.3.2, longer than the period programmed in C5.1.3.3.</p> $\text{Votalge imbalance (\%)} = \left(\frac{S1.2.x - S1.2.y}{C2.1} \right) \times 100\%$	<ul style="list-style-type: none"> - The power supply line voltage imbalance is greater than the programmed value. - Unbalanced system. - One phase loss at the supply voltage.
F002/A002: Motor Supply Undervoltage	<p>When the undervoltage value (as a percentage of C2.1) remains greater than the value programmed in C5.1.1.2, longer than the period programmed in C5.1.1.3.</p> $\text{Undervoltage (\%)} = (100\% - S1.2.5)$	<ul style="list-style-type: none"> - The power supply line undervoltage is greater than the programmed value. - A voltage drop while starting. - Undersized input transformer. - Phase loss at the supply voltage.
F003: Motor Start Phase Loss	<p>When any of the voltage synchronization pulses is missing at the initial starting moment.</p>	<ul style="list-style-type: none"> - Phase loss at the supply voltage. - Problems with the actuation of the input contactor. - Open input fuses. - Bad contact problems at the supply line connections. - Incorrect motor connection.
F005/A005: Motor Overload Thermal Class	<p>When the time determined by the tripping thermal class curve is exceeded (S4.2 and C5.9).</p>	<ul style="list-style-type: none"> - Starting cycles beyond the allowed. - Programmed tripping class lower than the allowed motor duty cycle. - The period between stopping and restarting is shorter than the time necessary for cooling down (C5.9.7.7). - Incorrect programming (C5.9).
F010: CCI Fault	<p>It is used in the communication between interface control card and motor control card.</p>	<ul style="list-style-type: none"> - Reserved.
F015: Motor Not Connected	<p>When any of the current synchronization pulses is missing at the initial starting moment.</p>	<ul style="list-style-type: none"> - Bad contact problems at the motor connections. - SCR or bypass contactor short-circuit.
F016/A016: Motor Supply Overvoltage	<p>When the overvoltage value (as a percentage of C2.1) remains greater than the value programmed in C5.1.2.2, longer than the period programmed in C5.1.2.3.</p> $\text{Overvoltage (\%)} = (S1.2.5 - 100\%)$	<p>O valor de sobretensão da rede de alimentação está superior ao programado para tensão nominal do motor (C2.1).</p> <ul style="list-style-type: none"> - Transformer tap selected with too high voltage. - Capacitive supply line with too low inductive load.
F018: Wrong Connection to the Motor	<p>When the value of the SSW output voltage is wrong with the motor disabled.</p>	<ul style="list-style-type: none"> - Poor contact problems on the motor connections. - Incorrect motor connections. - Motor inside delta connection programmed incorrectly (C9.2.1).
F019: Power Short Circuit: Motor Off	<p>When some of the S1.1 three-phase currents presents values 25% above the SSW rated current (C9.1.1) for a period longer than 50 ms.</p>	<ul style="list-style-type: none"> - Short circuit in the SSW power section, SCRs or bypass. - Problems with the current measurement circuit.
F020: Power Short Circuit: Motor On	<p>When some of the three-phase currents remains above five times the SSW rated current for a period longer than 0.75 ms with the motor running.</p>	<ul style="list-style-type: none"> - Short circuit in the SSW power section. - Short circuit on the cables that connect the SSW to the motor. - Short circuit in the motor. - Locked rotor. - Defective motor. - Momentary overloads or oscillating loads. - Incorrect current transformers.

Fault/Alarm	Description	Possible Causes
F032/A032: DI6 Motor Overtemperature	When DI6 input is programmed for the motor PTC input and the sensor actuates.	<ul style="list-style-type: none"> - Load on the motor shaft is too high. - Load cycle is too high, high number of starts and stops per hour. - High ambient temperature. - Poor contact or short circuit (resistance < 100) on the wiring to the DI6 input, coming from the motor thermistor. - Incorrect programming of DI6 for 15, without thermistor installed on the motor. - Stalled motor, locked rotor.
F040: Serial Communication Fault CCI-CCM	When the communication between the interface control board and the motor control board is interrupted. In order to clear this fault, it is necessary to power the SSW off and on again.	<ul style="list-style-type: none"> - Electrical noise in the electronics power supply above the allowed levels. - Missing or defective grounding on the electronics power supply. - Problems with the control boards.
F042: CPU Error (Watchdog)	Microcontroller watchdog fault.	<ul style="list-style-type: none"> - Electrical noise in the electronics power supply above the allowed levels. - Missing or defective grounding on the electronics power supply.
F051: SCRs Under Temperature	The temperature of SCRs heatsink is below the allowed value ($S4.1.1 \leq -20\text{ }^{\circ}\text{C}$).	<ul style="list-style-type: none"> - Lower than allowed ambient temperature. - Poor contact on the heatsink NTC cables.
F054: SCRs Overtemperature	The temperature of SCRs heatsink is above the allowed value.	<ul style="list-style-type: none"> - Starting cycles severer than the tolerated by the SSW model. - Disabled or defective fan, if present in that SSW model. - Ambient temperature is above the allowed value. - SCR mounting problems.
F057: R-U SCRs Fault F058: S-V SCRs Fault F059: T-W SCRs Fault	When no SCRs is fired for a period longer than 50 ms.	<ul style="list-style-type: none"> - One of the SCRs of the indicated arm has a defective gate. - Defective firing circuit. - Bad contact at the SCR firing cables in the indicated arm. - The motor current is insufficient to assure SCR conduction.
F061: Time Between Starts	The SSW received a command to start the motor before the minimum time interval between starts had elapsed (C5.7.3).	<ul style="list-style-type: none"> - Time between starts below allowed value. - Minimum interval between starts is programmed incorrectly.
F062: Start Overtime	When the maximum starting time programmed in C1.3 is exceeded during current limit, current ramp or torque control starting. Excess time in JOG.	<ul style="list-style-type: none"> - The motor has not developed the necessary starting torque. - The time programmed in C1.3 is less than the necessary. - The current limit programmed in C1.7 is too low. - Current limit values at any of the points used with the current ramp, are too low. - Torque limit values at any of the points used with torque control, are too low. - Stalled motor, locked rotor.
F063: Locked Rotor	When at the end of the acceleration ramp the current is not lower than 2x the rated motor current (C2.2) before the bypass relay closing.	<ul style="list-style-type: none"> - Incorrect motor rated current programmed in C2.2. - The time programmed in C1.3 is shorter than the required to start the motor with voltage ramp. - The transformer that supplies the motor may be saturated and requiring too much time to recover from the starting current. - Stalled motor, locked rotor. - C5.6.2 = 0 can be used with special motors that withstand this operation condition.

Fault/Alarm	Description	Possible Causes
F064: SCRs Overload	When the time limits given by the time x temperature curves of SCR protection are exceeded.	<ul style="list-style-type: none"> - Starting cycles severer than the tolerated by the SSW model. - Starting current too high. - Starting time too long. - The period between stopping and restarting is shorter than the time necessary. - Disabled or defective fan, if present in that SSW model.
F065/A065: Motor Undercurrent	When the undercurrent value (as a percentage of C2.2) remains greater then the value programmed in C5.2.1.2, longer than the period programmed in C5.2.1.3. $\text{Undercurrent (\%)} = (100\% - S1.1.5)$	<ul style="list-style-type: none"> - The motor undercurrent is greater than the programmed value. - In hydraulic pump applications, the pump may be rotating without load.
F066/A066: Motor Overcurrent	When the overcurrent value (as a percentage of C2.2) remains greater then the value programmed in C5.2.2.2, longer than the period programmed in C5.2.2.3. $\text{Overcurrent (\%)} = (S1.1.5 - 100\%)$	<ul style="list-style-type: none"> - The motor overcurrent is greater than the programmed value. - A momentary excess of motor load. - Stalled motor, locked rotor.
F067: Phase Reversal RST/123	When the synchronism signals do not follow the R/1L1, S/3L2, T/5L3 sequence.	<ul style="list-style-type: none"> - Unnecessary activation of phase sequence. - Incorrect line phase sequence. - The phase sequence could have been changed in another point of the supply line.
F068: Phase Reversal RTS/132	When the synchronism signals do not follow the R/1L1, T/5L3, S/3L2 sequence.	<ul style="list-style-type: none"> - Unnecessary activation of phase sequence. - Incorrect line phase sequence. - The phase sequence could have been changed in another point of the supply line.
F069: Control Supply Incorrect Voltage	When the control board power supply feeding voltage is out of specification.	<ul style="list-style-type: none"> - Incorrect voltage in the control power supply. - Bad contact at the control board power supply.
F070: Undervoltage Control Circuit	When the control board power supply feeding voltage is below 93.5 Vac.	<ul style="list-style-type: none"> - Phase loss at the control supply. - Bad contact at the control board power supply. - Open fuse in the control board power supply. It is a 5 x 20 mm 2A glass slow blow fuse.
F071: Bypass Contact Open - Not Closed	When a failure in the bypass contacts is detected at full voltage after starting.	<ul style="list-style-type: none"> - Bad contact in the bypass contactor control cables. - Defective contactor control board. - Defective contactor coil. - Defective contacts due to an overload.
F072: Overcurrent Before Bypass	When, at the end of the acceleration ramp, the current is not lower than two times the SSW rated current (C9.1.1) before the internal bypass relay closes.	<ul style="list-style-type: none"> - Incorrect setting of the SSW rated current (C2.2). - Maximum time set to the acceleration ramp is shorter than necessary to start the motor by voltage ramp. - Motor rated current above the current the SSW withstands. - Stalled motor, locked rotor.
F074/A074: Motor Current Inbalance	When the difference between phase current values (as a percentage of C2.2) is greater then the value programmed in C5.2.3.2, longer than the period programmed in C5.2.3.3. $\text{Current imbalance (\%)} = \left(\frac{S1.1.x - S1.1.y}{C2.2} \right) \times 100\%$	<ul style="list-style-type: none"> - The current imbalance is greater than the programmed value. - A voltage drop in one or more phases of the supply line. - Phase loss in the supply line. - Undersized input transformer. - Open input fuses. - Bad contacts in the line supply and/or motor connections.

Fault/Alarm	Description	Possible Causes
F075: Frequency Out of Range	When the line frequency remains outside the limits 50Hz ±10% or 60Hz ±10%, longer than 0.5 s with the motor on.	- The SSW being fed by a generator that is not withstanding the full load operation or the motor starting.
F076: Bypass Undercurrent	When at the end of the acceleration ramp, before the bypass closing, the current is lower than 0.1 x the SSW rated current (C9.1.1).	- A failure in the supply line voltage, or of an SCR, before closing the bypass contactor. - Incorrect programming of the SSW rated current in C9.1.1. - Rated motor current below the minimum current (C9.1.1 x 0.1). - It can be disabled for test purposes by setting C5.6.1 = 0.
F077: Bypass Contact Closed - Not Opened	When the bypass contactor opening does not occur.	- Short-circuit in the bypass contactor control cables. - Defective contacts due to an overload. - Short-circuit in parallel with the bypass contactor: Shorted SCRs, external short-circuit, external bypass.
F078/A078: Motor Undertorque	When the undertorque value (in percentage) remains greater then the value programmed in C5.3.1.2, longer than the period programmed in C5.3.1.3. $\text{Undertorque (\%)} = (100\% - S1.7.1)$	- The motor undertorque is greater than the programmed value. - In hydraulic pump applications, the pump may be rotating without load.
F079/A079: Motor Overtorque	When the overtorque value (in percentage) remains greater then the value programmed in C5.3.2.2, longer than the period programmed in C5.3.2.3. $\text{Overtorque (\%)} = (S1.7.1 - 100\%)$	- The motor overtorque is greater than the programmed value. - A momentary excess of motor load. - Stalled motor, locked rotor.
F080/A080: Motor Underpower	When the underpower value (in percentage) remains greater then the value programmed in C5.4.1.2, longer than the period programmed in C5.4.1.3. $\text{Underpower (\%)} = \left(\frac{C2.4 - S1.5.1}{C2.4} \right) \times 100\%$	- The motor underpower is greater than the programmed value. - In hydraulic pump applications, the pump may be rotating without load.
F081/A081: Motor Overpower	When the overpower value (in percentage) remains greater then the value programmed in C5.4.2.2, longer than the period programmed in C5.4.2.3. $\text{Overpower (\%)} = \left(\frac{S1.5.1 - C2.4}{C2.4} \right) \times 100\%$	- The motor overpower is greter than the programmed value. - A momentary excess of motor load. - Stalled motor, locked rotor.
F082: Slot1 Fault - Incompatible Accessory	Accessory installed in SLOT1 is not compatible with the SSW firmware.	- SSW firmware outdated. Firmware update is required. - Problem with accessory installed in SLOT1.
F083: Slot2 Fault - Incompatible Accessory	Accessory installed in SLOT2 is not compatible with the SSW firmware.	- SSW firmware outdated. Firmware update is required. - Problem with accessory installed in SLOT2.
F084: Self-diagnostic Fault	It indicates some problem found during the operating system initialization. The following messages may appear on the HMI, "F084 Init. Error:" 1 - Parameter Area. 2 - SPI. 3 - External FLASH. 4 - Incompatible TXT Firmware Package. 5 - Incompatible MOT Firmware Package. 6 - HMI not initialized. 7 - CCM Initialization. 8 - History files not initialized.	- Error saving the SSW firmware package. - Error in the generation of the SSW firmware package. - Problems with SSW control card. Note: The SSW STATUS LED, located above the accessory slots, flashes red with the number of the auto-diagnostic fault.
F085: Slot1 = Slot2 Fault	Two identical accessories installed on the SSW.	- The SSW accepts accessories in any SLOT, but only one type of each accessory is allowed.

Fault/Alarm	Description	Possible Causes
F086: Slot1 Fault - Configured	Mandatory accessory in SLOT1 is not installed.	<ul style="list-style-type: none"> - The mandatory accessory in SLOT1 is not installed or was removed. - Incorrect mandatory accessory programming (C9.3.1). - Problem with accessory installed.
F087: Slot2 Fault - Configured	Mandatory accessory in SLOT2 is not installed.	<ul style="list-style-type: none"> - The mandatory accessory in SLOT2 is not installed or was removed. - Incorrect mandatory accessory programming (C9.3.2). - Problem with accessory installed.
F088: Slot1 Fault - Connection	Connection failure with accessory installed in SLOT1.	<ul style="list-style-type: none"> - The accessory in SLOT1 was removed. - Problem with accessory installed in SLOT1.
F089: Slot2 Fault - Connection	Connection failure with accessory installed in SLOT2.	<ul style="list-style-type: none"> - The accessory in SLOT2 was removed. - Problem with accessory installed in SLOT2.
A090: External Alarm (DI)	When a digital input (DI1 to DI6) programmed for No External Alarm is opened.	<ul style="list-style-type: none"> - Open wiring at DI1 to DI6 inputs, when programmed for no external alarm (C4.1.1 a C4.1.6).
F091: External Fault (DI)	When a digital input (DI1 to DI6) programmed for No External Fault is opened.	<ul style="list-style-type: none"> - Open wiring at DI1 to DI6 inputs, when programmed for no external fault (C4.1.1 a C4.1.6).
F099: Current Invalid Offset	When the reading of a current input is out of the acceptable range of 2.5 V ± 3%.	<ul style="list-style-type: none"> - Bad contact in the cables that connect the current transformers to the control boards. - Shorted SCR or bypass contactor. - Defective control board.
F101/A101: Ch1 Motor Overtemperature F102/A102: Ch2 Motor Overtemperature F103/A103: Ch3 Motor Overtemperature F104/A104: Ch4 Motor Overtemperature F105/A105: Ch5 Motor Overtemperature F106/A106: Ch6 Motor Overtemperature	When the temperature value (S4.3) is greater than or equal to the programmed value (C5.8).	<ul style="list-style-type: none"> - Motor overtemperature. - Motor overload. - Starting cycles severer than the tolerated by the motor. - The motor does not produce enough torque for the starting. - Fault trip and alarm activation levels lower than the tolerated by the motor (motor insulation class).

Fault/Alarm	Description	Possible Causes
F109/A109: Ch1 - Motor Temperature Broken Cable F110/A110: Ch2 - Motor Temperature Broken Cable F111/A111: Ch3 - Motor Temperature Broken Cable F112/A112: Ch4 - Motor Temperature Broken Cable F113/A113: Ch5 - Motor Temperature Broken Cable F114/A114: Ch6 - Motor Temperature Broken Cable	It detects the opening of the temperature measurement channels due to the rupture of any of the three sensor cables.	<ul style="list-style-type: none"> - Motor temperature sensor broken cable. - Temperature channel programmed for fault or alarm without a sensor connected to it at the PT100 board. - Disconnected PT100 terminal strips. Note: The selection between fault and alarm for broken cable is done at C5.8.2, C5.8.5, C5.8.8, C5.8.11, C5.8.14 and C5.8.17
F117/A117: Ch1 - Motor Temperature Short Circuit F118/A118: Ch2 - Motor Temperature Short Circuit F119/A119: Ch3 - Motor Temperature Short Circuit F120/A120: Ch4 - Motor Temperature Short Circuit F121/A121: Ch5 - Motor Temperature Short Circuit F122/A122: Ch6 - Motor Temperature Short Circuit	It detects temperature measurement channel short-circuits, through short-circuit between the three cables of each sensor.	<ul style="list-style-type: none"> - Short-circuit at the motor temperature sensor cables. Note: The selection between fault and alarm for short-circuit is done at C5.8.2, C5.8.5, C5.8.8, C5.8.11, C5.8.14 and C5.8.17.
F127/A127: HMI Communication Timeout	It indicates that the SSW stopped communicating with its HMI for a period longer than the setting (C6.6). The time only starts to count after the first communication with the SSW HMI.	<ul style="list-style-type: none"> - Check connections with HMI.
F128/A128: Serial Communication Timeout	It indicates that the SSW stopped receiving valid telegrams for a period longer than the setting (C8.2.5.3). The time counting starts as soon as it receives the first valid telegram, with address and error-checking field correct.	<ul style="list-style-type: none"> - Check network installation, broken cable or fault/poor contact on the connections with the network, grounding. - Make sure that the master sends telegrams to the equipment in intervals shorter than the programmed (C8.2.5.3). - Disable this function (C8.2.5.1).
F129/A129: Anybus Offline	It indicates communication interruption of Anybus-CC accessory with network master.	<ul style="list-style-type: none"> - The master PLC went to the idle or programming state. - Programming error, the number of programmed I/O words in the slave differs from the number adjusted in the master. - Lose of communication with the master (broken cable, disconnected connector etc.).

Fault/Alarm	Description	Possible Causes
F130: Anybus Access Fault	It indicates access error to the Anybus-CC communication module. It actuates when the SSW cannot exchange data with the Anybus-CC accessory, when the Anybus module identifies some internal fault, or when there is a hardware incompatibility. In order to remove this fault, it is necessary to power the SSW off and on again.	<ul style="list-style-type: none"> - Check that the accessory is properly fitted. - Check that the equipment firmware version supports the Anybus accessory. - Hardware errors due to improper handling or installation of the accessory, for example, may cause this error. - If possible, carry out tests by replacing the communication accessory.
F131/A131: Anybus Modbus TCP Timeout	It indicates fault in the Modbus TCP communication for Anybus-CC accessory. It occurs when the equipment stopped receiving valid write requests to the Slot Command Word or Data Write Words for a period longer than the programmed (C8.3.9.3). The time counting starts as soon as it receives the first valid write request.	<ul style="list-style-type: none"> - Check network installation, broken cable or fault/poor contact on the connections with the network, grounding. - Make sure that the Modbus TCP client sends telegrams to the equipment in intervals shorter than the programmed (C8.3.9.3). - Disable this function (C8.3.9.1).
F132/A132: Anybus Idle	It indicates that network master changed to idle or programming state.	<ul style="list-style-type: none"> - How to detect this condition depends on the communication protocol and the network master.
F133/A133: CAN Interface without Power Supply	It indicates that the CAN interface does not have power supply between the pins 1 and 5 of the connector. It actuates when the CAN interface is connected to the power supply and the absence of power is detected.	<ul style="list-style-type: none"> - Measure the voltage between the pins 1 and 5 of the CAN interface connector. - Verify if the power supply cables have not been changed or inverted. - Make sure there is no contact problem in the cable or in the CAN interface connector.
F134/A134: Bus Off	The bus off error in the CAN interface has been detected. If the number of reception or transmission errors detected by the CAN interface is too high, the CAN controller can be taken to the bus off state, where it interrupts the communication and disables the CAN interface. In order that the communication be reestablished, it will be necessary to cycle the power of the product, or remove the power supply from the CAN interface and apply it again, so that the communication be reinitiated.	<ul style="list-style-type: none"> - Verify if there is any short-circuit between the CAN circuit transmission cables. - Verify if the cables have not been changed or inverted. - Verify if all the network devices use the same baud rate. - Verify if termination resistors with the correct values were installed only at the extremes of the main bus. - Verify if the CAN network installation was carried out in proper manner.
F135/A135: CANopen Offline	It occurs when CANopen node state changes from operational to pre-operational.	<ul style="list-style-type: none"> - Verify the error control mechanisms operation (Heartbeat/Node Guarding). - Verify if the master is sending the guarding/heartbeat telegrams in the programmed time. - Verify communication problems that can cause telegram losses or transmission delays.
F136/A136: Idle Master	It actuates when communicating with the master of the DeviceNet network in Run mode and a transition to Idle mode is detected.	<ul style="list-style-type: none"> - Adjust the switch that commands the master operation mode for execution (Run) or set the correspondent bit in the configuration word of the master software. In case of doubts, referer to used master documentation.
F137/A137: DeviceNet Connection Timeout	It indicates that one or more DeviceNet I/O connections have expired. It occurs when, for any reason, after the cyclic communication of the master with the product is started, this communication is interrupted.	<ul style="list-style-type: none"> - Check the status of the network master. - Check the network installation, broken cable or failed/bad contact in the network connections.
A177: Fan Replacement	Fan replacement alarm (above 40000 hours).	<ul style="list-style-type: none"> - The heatsink fan maximum number of operating hours has been reached. <p>Note: After replacing the fan D6.3 counter can be reset by setting C10.3.1=7.</p>

Fault/Alarm	Description	Possible Causes
A181: Battery Low Voltage	The clock battery voltage is low.	<ul style="list-style-type: none"> - Need to replace the battery. - No battery installed or poorly connected.
A182: Invalid Clock Value	Invalid clock value.	<ul style="list-style-type: none"> - It is necessary to set date and time (C6.3.1). - Discharged, defective or not installed battery.
F708/A708: SoftPLC Application Not Running	SoftPLC Application not running.	<ul style="list-style-type: none"> - SoftPLC Application is stopped (C11.1 = Stop Program). - SoftPLC state (S6.1.1) presents application incompatible with the firmware version of the SSW900.
F750/A750 to F799/A799: SoftPLC Fault or Alarm	SoftPLC Fault or Alarm.	-For more details, refer to the Help text of WPS (WEG Programming Suite) Software.

Fault and alarm operation:

- Faults operate by indicating their occurrence on the HMI, in the status SSW word (S3.1.1), in the present alarm parameters (D1.1 and D1.2) and disabling the motor. They can only be reset with a reset command or de-energizing the control boards.
- Alarms operate by indicating their occurrence on the HMI, in the status SSW word (S3.1.1), in the present alarm parameters (D2.1 and D2.2). They are automatically reset when the alarm condition ceases existing.

3 SAFETY NOTICES

This manual contains the information necessary for the correct SSW900 programming.

It has been written to be used by qualified personnel with suitable training or technical qualification for operating this type of equipment.

3.1 SAFETY NOTICES IN THIS MANUAL

The following safety notices are used in this manual:



DANGER!

The nonobservance of the procedures recommended in this warning can lead to death, serious injuries and considerable material damage.



WARNING!

The nonobservance of the procedures recommended in this warning can lead to material damage.



NOTE!

The text intends to supply important information for the correct understanding and good operation of the product.

3.2 SAFETY NOTICES ON THE PRODUCT

The following symbols are attached to the product, serving as safety notices:



High voltages are present.



Components sensitive to electrostatic discharge. Do not touch them.



Mandatory connection to the protective earth (PE).



Connection of the shield to the ground.

3.3 PRELIMINARY RECOMMENDATIONS

DANGER!

Only qualified personnel familiar with the SSW900 and associated equipment should plan or implement the installation, start-up and subsequent maintenance of this equipment. These personnel must follow all the safety instructions included in this manual and/or defined by local regulations. Failure to comply with these instructions may result in life threatening and/or equipment damage.

NOTE!

For the purposes of this manual, qualified personnel are those trained to be able to:

1. Install, ground, energize and operate the SSW according to this manual and the effective legal safety procedures.
2. Use protective equipment according to the established standards.
3. Give first aid services.

DANGER!

Always disconnect the input power before touching any electrical component associated to the SSW900. High voltages and rotating parts (fans) may be present even after disconnecting the power supply. Wait at least 3 minutes for the complete discharge of the capacitors and the stopping of the fans. Always connect the equipment frame to the protective earth (PE) at the suitable connection point.

WARNING!

Electronic boards have components sensitive to electrostatic discharges. Do not touch directly on components or connectors. If necessary, touch the grounded metallic frame before or use an adequate grounded wrist strap.

Do not perform any high pot tests with the SSW900!
If it is necessary, consult the manufacturer.

NOTE!

SSW900 may interfere with other electronic equipments. In order to minimize these effects, take the precautions recommended in the installation and connection chapter of this manual.

NOTE!

Read the Soft-Starter SSW900 User's Manual completely before installing or operating the SSW900.

4 ABOUT THIS MANUAL

This manual presents the necessary information for the configuration of all of the functions and parameters of the Soft-Starter SSW900. This manual must be used together with the Soft-Starter SSW900 User's Manual.

Because of the variety of functions of this product, it is possible to apply it in ways different from those presented hereby. It is not the purpose of this manual to exhaust all the SSW application possibilities, neither can the manufacturer assume any responsibility for the use of the SSW not based in this manual.

Reproduction of this manual content is prohibited, as a whole or in parts, without written permission from WEG.

4.1 TERMINOLOGY AND DEFINITIONS

4.1.1 Terms and Definitions Used in the Manual

Amp, A: Ampere.

° **C:** Degrees Celsius.

CA: Alternating Current.

DC: Direct Current.

CV: "Cavalo Vapor" = 736 Watts (power measurement unit, normally used to indicate the mechanical power of electric motors).

HMI: Human-Machine Interface; It is the device that allows the control of the motor, the visualization and the modification of the SSW parameters. It presents keys for commanding the motor, navigation keys and a graphic LCD display.

hp: "Horse Power" = 746 Watts (power measurement unit, normally used to indicate the mechanical power of electric motors).

Hz: hertz.

mA: miliamper = 0,001 ampere.

RAM Memory: volatile memory "Random Access Memory".

FLASH Memory: non-volatile memory.

h: hour.

min: minute.

s: second.

ms: millisecond = 0,001 seconds.

Nm: Newton meter; torque measurement unit.

PE: Protective Earth.

PLL: "Phase-Locked Loop".

RMS: "Root mean square"; effective value.

rpm: revolutions per minute: speed measurement unit.

RTC: "Real Time Clock".

SCR: "Silicon Controlled Rectifier".

hrlt: hot locked rotor time.

clrt: cold locked rotor time.

USB: "Universal Serial Bus"; it is a type of connection in the perspective of the "Plug and Play" concept.

V: volts.

WPS: Programming software "WEG Programming Suite".

Ω : ohms.

4.1.2 Symbols for the Parameter Properties Description

stopped: Parameter that can be changed only with a stopped motor.

5 SOFTWARE VERSIONS

It is important to note the software version installed in the SSW, since it defines the functions and the programming parameters of the SSW.

The SSW900 allows viewing all the versions installed (S3.2). Software versions of the entire package, control boards, HMI and even accessories, if installed.

This manual refers to control 1 and control 2 software version, as indicated on the back cover. For instance, version 1.0X means from 1.00 to 1.09, where the “X” is the software evolutions that do not affect the content of this manual.

6 ABOUT THE SSW900 SOFT-STARTER

The “Soft-Starter SSW900” is a high performance product that allows the starting/stopping control and protection of medium voltage three-phase induction motors, thus preventing mechanical shocks at the load, current peaks in the supply line and damage to the motor.

The new friendlier graphic interface provides easy data access with online help for all available data and recording of several states of the SSW saved by events.

One of the main characteristics of this product is the great robustness in the fault and alarm detection techniques used to monitor the supply line and the connections. It makes it possible for the customer to choose the best form of protecting the motor:

- Programmable protections for supply line overvoltage, undervoltage, and voltage imbalance between phases;
- Programmable motor no load and heavy load condition protections;
- Motor thermal protections;
- Programmable selection between fault trip or alarm indication for the protections.

Special functions like

- Status:
 - motor three-phase current in several units;
 - three-phase supply line voltage in several units;
 - motor supply voltage;
 - blocking voltage of the SCRs in V;
 - motor power in kW, kVA and kVAr and P.F.;
 - supply line frequency in Hz;
 - motor torque;
 - external and internal electronics supply voltage in V;
 - digital input and output status;
 - analog output value in different units;
 - General SSW status, such as: model, software versions, fan and accessories installed;
 - thermal class protection status;
 - SCR heatsink temperature;
 - motor temperature by using the temperature measurement accessory module;
 - status of all communication types available on the SSW, with their respective commands.
- Diagnostics:
 - faults, with history of all faults and storage of several SSW states in CSV file;
 - alarms, with history of all alarms and storage of several SSW states in CSV file;
 - event history with storage of several SSW states in CSV file;
 - all saved with date and RTC time;
 - maximum and average starting current, starting real time;
 - maximum current at full voltage;
 - maximum and minimum supply line voltage with the motor running;
 - maximum and minimum supply line frequency with the motor running;
 - maximum number of starts per hour, total number of starts;
 - powered time, enabled time, enabled fan time, kWh consumed;
 - maximum SCR temperature, maximum motor temperature by using the accessory module;
 - changed parameters.
- Configurations:
 - virtually all the SSW900 operation can be programmed;
 - totally flexible selection of starting and stopping control types;
 - LOC/REM selection for several command sources;
 - totally programmable inputs and outputs;
 - totally programmable protections with fault or alarm actuation;











- several protections against communication faults;
 - several HMI screen settings and graphic monitoring of the Status;
 - motor inside delta connection is possible;
 - two accessory modules can be used;
 - special functions: braking, rotation direction change, JOG, kick start.
- Assistant:
 - minimum programming sequence necessary to put the SSW in operation.
 - Others:
 - Status monitoring with a supervisory program through Serial or Fieldbus communication;
 - graphic monitoring and programming through Software on the PC (WPS);
 - SoftPLC which allows the implementation of a PLC software or special SSW operation modes.

7 HMI

The HMI allows commanding the SSW, visualizing and setting all the parameters. The navigation is similar to cell phones, with access to all data by means of groups (Menus).



Figure 7.1: HMI Soft Keys.

-  USB connector for communication with the PC.
-  “Esc”: Cancels programming. Goes back in the menu.
-  “Help”: Shows help text referring to the marked content.
-  Increases and Decreases values. Navigation in the menu system.
-  Changes the main screen. Moves within values. Navigation in the menu system.
-  Enter soft key: Saves changes. Enters the menus.
-  Motor rotation direction control, if programmed for the HMI.
-  Selects LOCAL or REMOTO control, if programmed for the HMI.
-  JOG, if programmed for the HMI.
-  Stops the motor, if programmed for the HMI. Faults reset.
-  Starts the motor, if programmed for the HMI.

8 HMI OPERATION

The entire HMI operation is based on menus, which contain the reading and writing variables. The menus are divided into levels with menus e submenus.

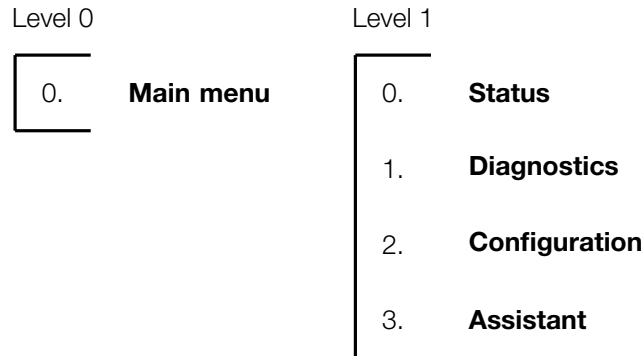

Figure 8.1: HMI Screens and Menus.

Level 0:

It contains the main screen, where you can choose the reading variables (**Status**) to be displayed.

Level 1:

It contains the main menus to access the variables, which are then divided into reading variables (**Status** and **Diagnostics**) and writing or programming variables (**Configurations** and **Assistant**).

The **Status** cannot be changed through the HMI; however, that **Status** may be a **Configuration** for a certain communication network. Therefore, it can be changed through this communication network and only viewed on the HMI.

8.1 MAIN SCREEN – LEVEL 0

After the SSW energization, the HMI initializes on the **Mainscreen**, where you can view reading variables (**Status**).

There are three main screens, which can be configured to display up to nine variables on each screen. In order to customize those main screens, refer to Chapter 8.6.

Examples: voltage, current, motor power and power factor...

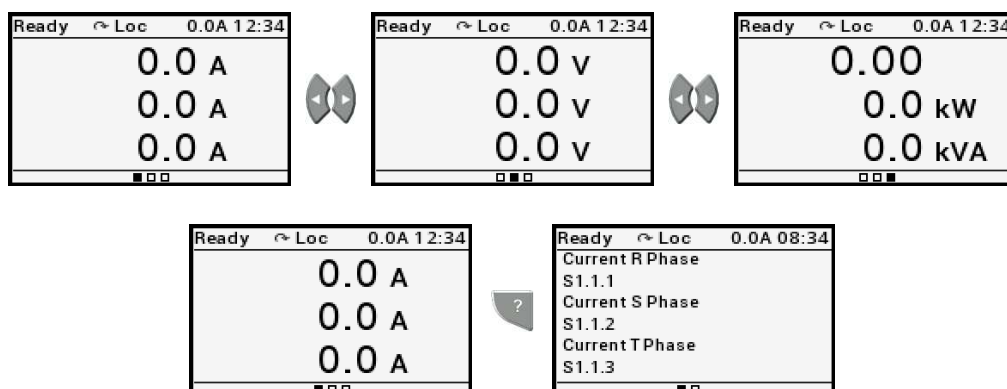

Figure 8.2: Standard main screens.

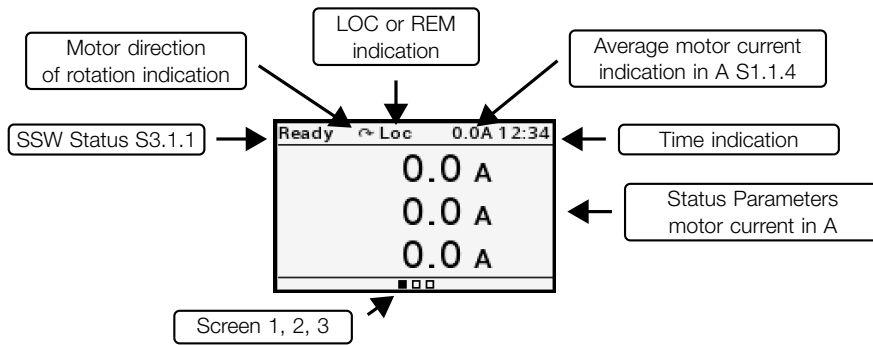

Figure 8.3: Main screen data.

In order to exit the main screens and access the menus, just press the "Enter" soft key.

8.2 MENU ACCESS MODE – MENU LEVELS

When you press the "Enter" soft key on a main screen, you access the menus. In the menu, you can navigate the groups and subgroups to access the variables, as shown in Chapter 1.

Each variable has its own coding, containing the information on its location in the menu structure and its identification. Digits are separated by a point.

Example:

C4.1.3 = Digital input function DI3

C4.1.3 = Configurations\I/O\Digital inputs\DI3

Level 1	Level 2	Level 3	Level 4	Edition
C	C4	C4.1	C4.1.3	Function
Configurations	I/O	Digital inputs	DI3	

8.2.1 Reading Variables – Status and Diagnostics

All reading variables for the HMI are available in two main menus: **Status** and **Diagnostics**.

Status – reading variables with updated variables: current, voltage and others.

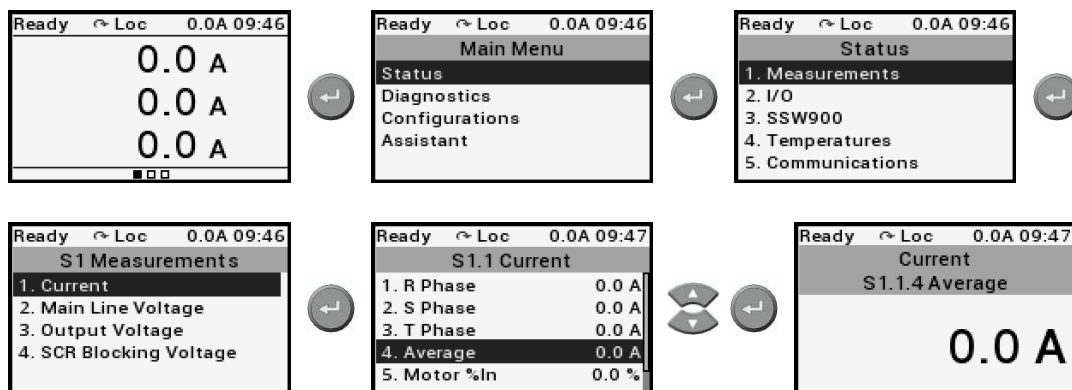

Figure 8.4: Motor average current reading in A

Diagnostics – reading variables with saved values due to events: faults, alarms, start and others.

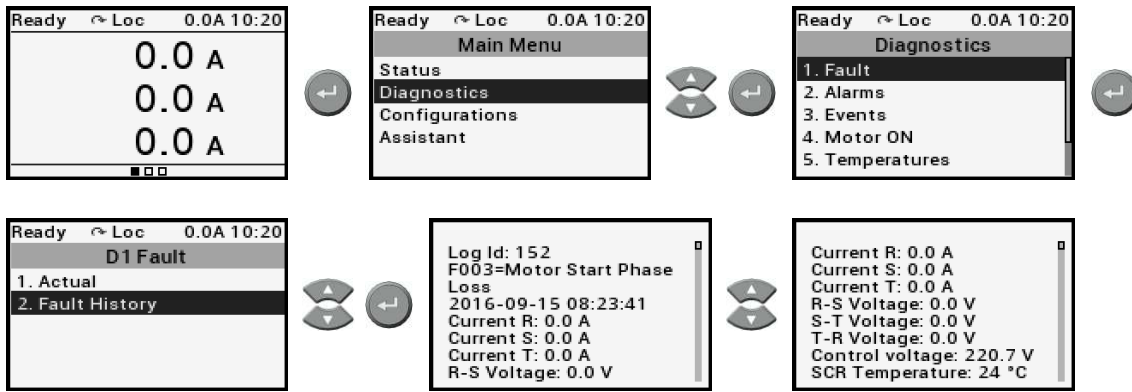

Figure 8.5: Fault history reading.

8.2.2 Writing Variables - Configurations

Every SSW programming or configuration is executed through this menu, which is divided into programming submenus, groups or subgroups, as presented in Chapter 1.

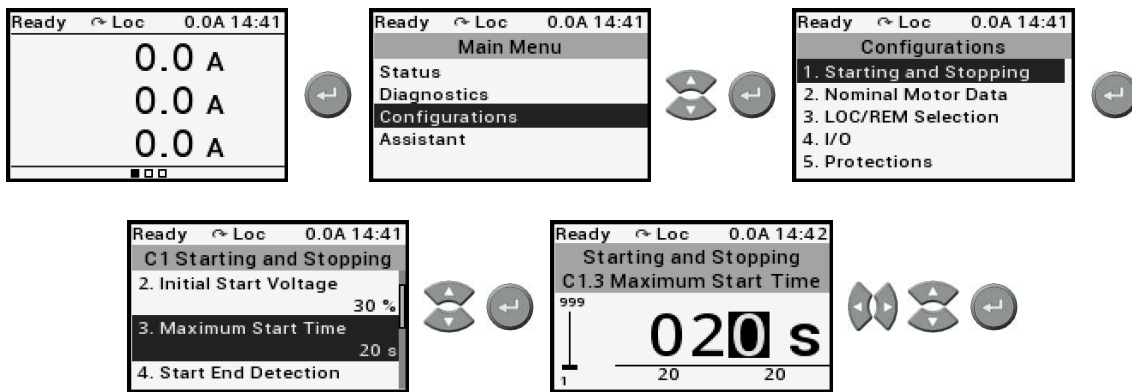

Figure 8.6: Programming of the maximum starting time.

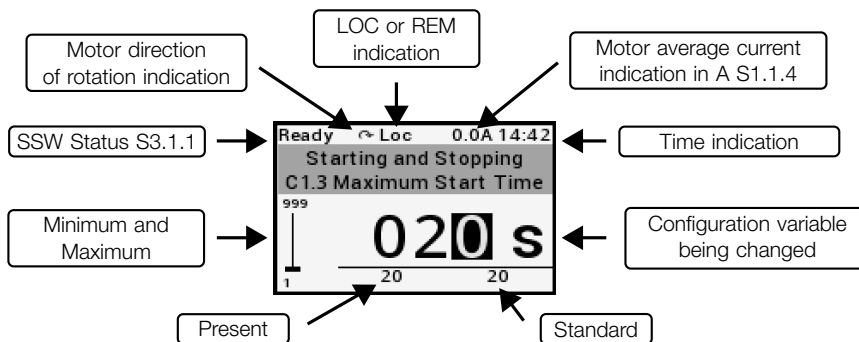

Figure 8.7: Configuration screen data.

8.2.3 Writing Variables – Assistant

In the assistant, some of the most used programmings are arranged sequentially so as to facilitate the SSW start-up. For further details, refer to Chapter: 12.

8.3 HELP SOFT KEY

The help “ ? ” soft key provides further information on the selected text. This soft key can be used at any moment.

In case the selected text is a parameter, when you press the “?” soft key, the screen displays information on this parameter.

The figures below show some examples of use of the help “?” soft key.

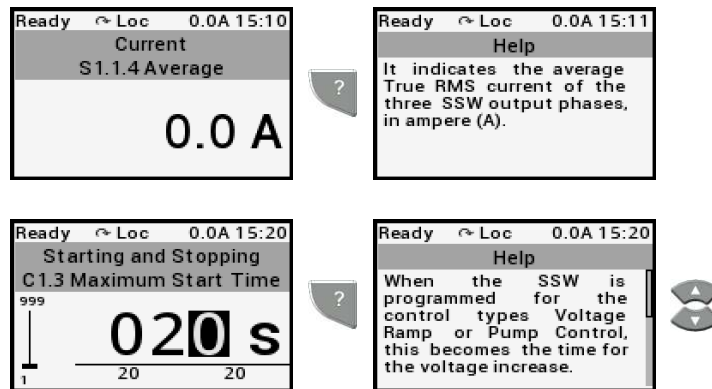

Figure 8.8: Example of use of the help soft key.

8.4 PASSWORD SETTING

In order to change the SSW configurations, it is necessary to set the password properly in C6.1.1. Otherwise, the configurations can only be viewed.

When you try to make some change, the access password is requested, in case C6.1.1 is incorrectly set. The factory default password is 5.

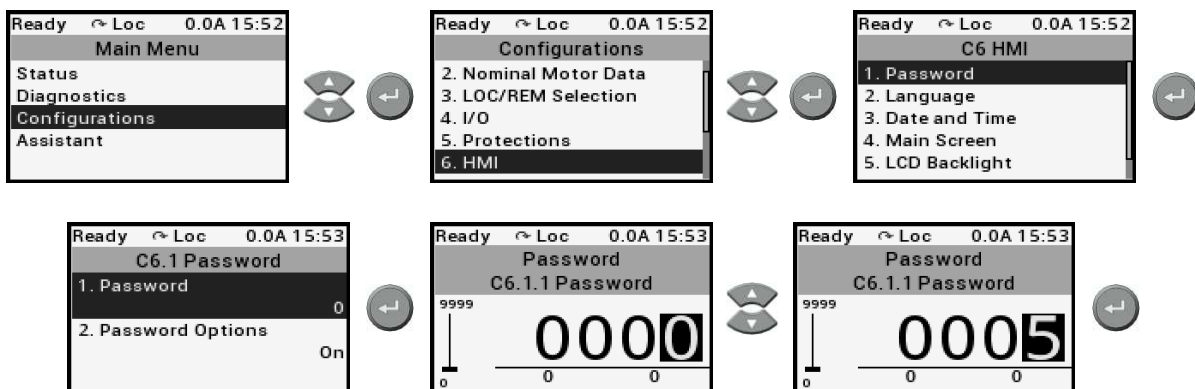

Figure 8.9: Password to allow parameter changes.

It is possible to customize the password through C6.1.2. See detailed description of C6.1 in this manual.

8.5 DATE AND TIME SETTING

The date and time setting must be started from the configurations menu, as shown below.

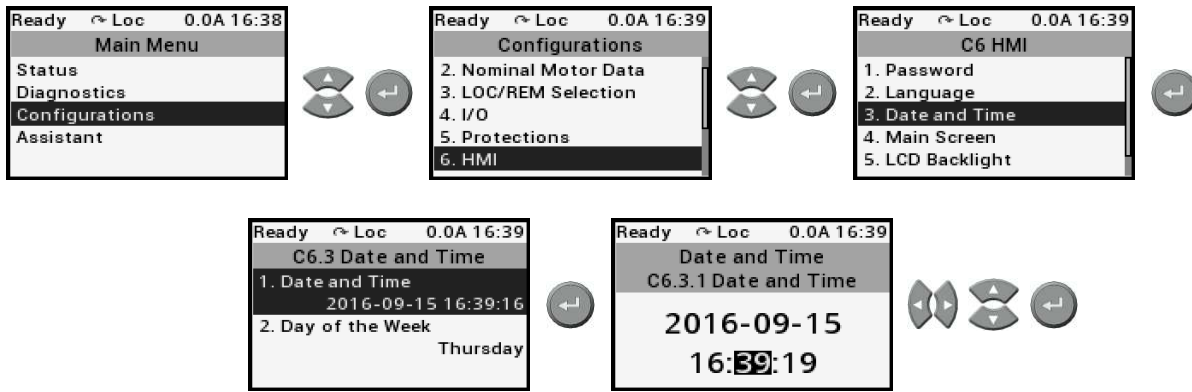

Figure 8.10: Date and time setting.

8.6 MAIN SCREEN SETTING

The customization of the main screens allows defining what will always be displayed at the SSW energization. Three easy-access screens are available. Each main screen can be configured in the following formats:

- Text - 3 per Line
- Text - 1 per Line
- Text - Full Screen
- Numeric - 1 per Line
- Bar - 1 per Line
- Bar - Full Screen
- Graphic - Full Screen

The following figure shows how to select a graph for a main screen.

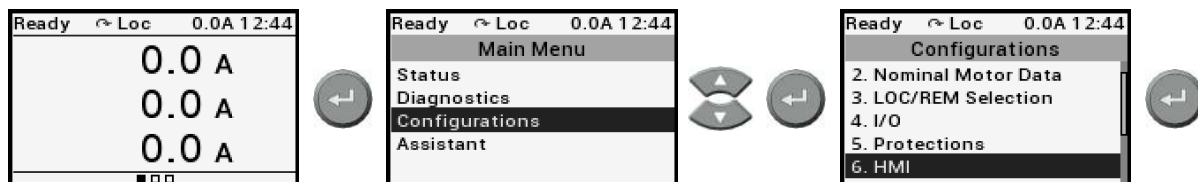

First, select "Main Screen" on the "HMI".

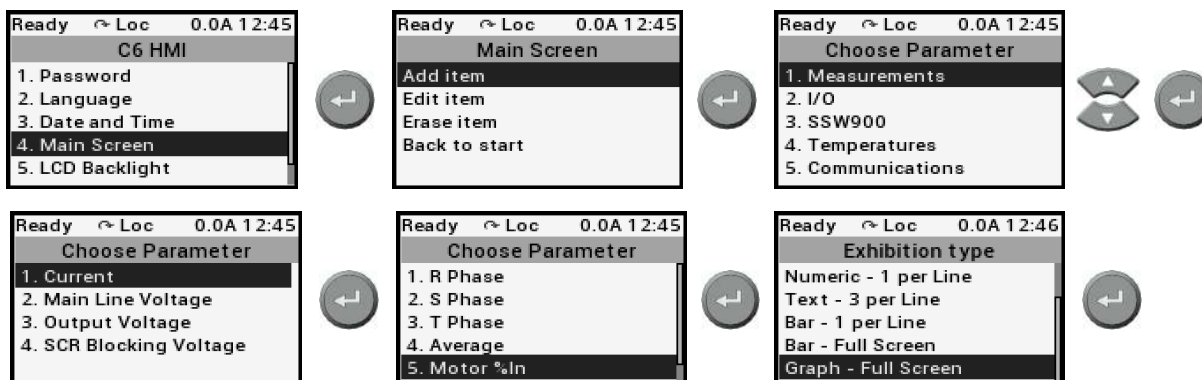

Then, select the Status you wish to show on the graph.

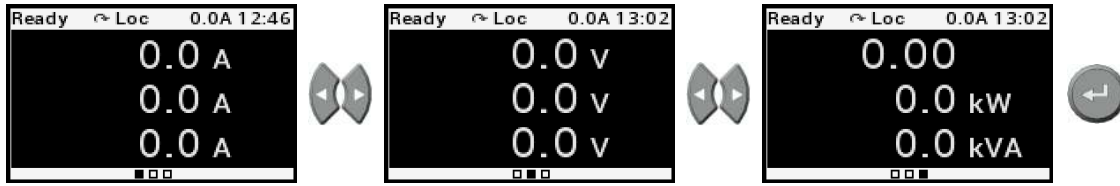

After that, you choose which main screen will show the graph..

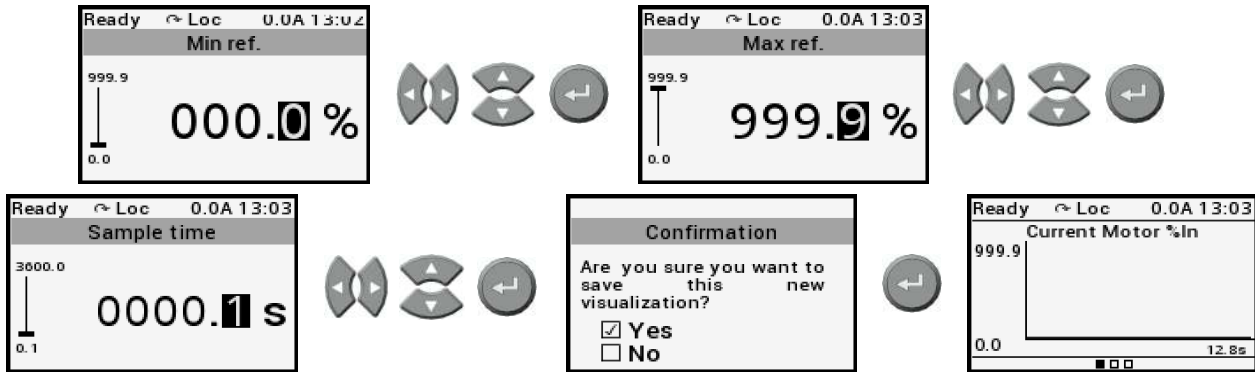

Next, select 'Graph - Full Screen'. When doing so, you must select the graph amplitude range and the sampling rate.

Other examples of screens can also be done:

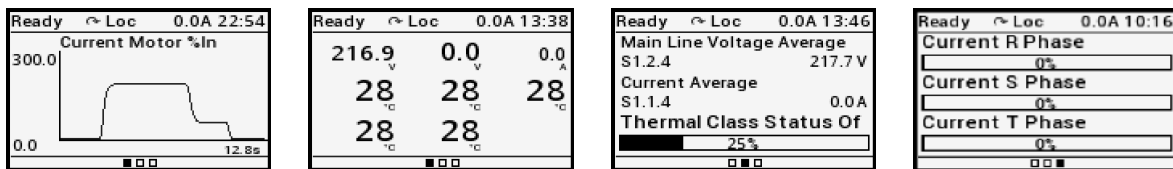

Figure 8.11: Examples of main screens.

The first screen is an example with “Graph - Full Screen” of a motor start, showing:
 - the average three-phase starting current in percentage of the motor rated current (full scale 5 x In Motor).

The second screen is an example with “Text - 3 per Line”, showing:
 - in the first line, the average three-phase voltage of the the supply line, the average three-phase voltage of the motor, the average three-phase current of the motor;
 - in the second line, the motor stator winding temperatures;
 - in the third line, the motor bearing temperatures (PT100 accessory).

The third screen is an example with “Text - 1 per Line” and “Bar - 1 per Line”, showing:
 - in the first line, the average three-phase voltage of the supply line;
 - in the second line, the average three-phase current of the motor;
 - in the third line, the state of the motor thermal class protection.

The fourth screen is an example with “Bar - 1 per Line”, showing:
 - in the first line, phase R current in A;
 - in the second line, phase S current in A;
 - in the third line, phase T current in A.

9 S STATUS

Allows viewing of the SSW reading variables.

S1 MEASUREMENTS

Allows viewing the variables measured on the SSW circuits.

S1.1 Current

.1 R Phase	0.0 ... 14544.0 A
.2 S Phase	0.0 ... 14544.0 A
.3 T Phase	0.0 ... 14544.0 A
.4 Average	0.0 ... 14544.0 A
.5 Motor %In	0.0 ... 999.9 %
.6 SSW %In	0.0 ... 999.9 %

Description:

It indicates the output currents with True RMS calculation.

- .1 R Phase** It indicates output phase R True RMS current in ampere (A).
- .2 S Phase** It indicates output phase S True RMS current in ampere (A).
- .3 T Phase** It indicates output phase T True RMS current in ampere (A).
- .4 Average** It indicates the average True RMS current of the three SSW output phases, in ampere (A).
- .5 Motor %In** It indicates the average True RMS current of the three SSW output phases as a percentage of the motor rated current.
- .6 SSW %In** It indicates the average True RMS current of the three SSW output phases as a percentage of the SSW nominal current.

Accuracy of $\pm 3\%$ from 10% up to 500% of the SSW rated current.



NOTE!

When using the connection within the delta motor connection (C9.2.1=1), the indications of the current values will already be multiplied by 1,73.

S1.2 Main Line Voltage

.1 R-S Line	0.0 ... 999.9 V
.2 S-T Line	0.0 ... 999.9 V
.3 T-R Line	0.0 ... 999.9 V
.4 Average	0.0 ... 999.9 V
.5 Motor %Vn	0.0 ... 999.9 %
.6 SSW %Vn	0.0 ... 999.9 %

Description:

It indicates the input line voltages with True RMS calculation.

- .1 R-S Line** It indicates the R-S line voltage in volts (V).
- .2 S-T Line** It indicates the S-T line voltage in volts (V).

.3 T-R Line It indicates the T-R line voltage in volts (V).

.4 Average It indicates the average True RMS line voltage among the three input phases, in volts (V).

.5 Motor %Vn It indicates the average of the three input phases as a percentage of the motor nominal voltage.

.6 SSW %Vn It indicates the average of the three input phases as a percentage of the SSW nominal voltage.

Accuracy of $\pm 2\%$ of the SSW maximum voltage (S3.3.2).



NOTE!

The voltage will just be indicated when it reaches a value above 3% of the maximum SSW voltage (S3.3.2). Below this value it will only indicate 0 (zero).

S1.3 Output Voltage

.1 Average	0.0 ... 999.9 V
.2 Motor %Vn	0.0 ... 999.9 %

Description:

It indicates the output line voltages with True RMS calculation.

.1 Average It indicates the average True RMS line voltage among the three output phases, in volts (V).

.2 Motor %Vn It indicates the average of the three output phases as a percentage of the motor nominal voltage.

Accuracy of $\pm 2\%$ of the SSW maximum voltage (S3.3.2).



NOTE!

The voltage will just be indicated when it reaches a value above 3% of the maximum SSW voltage (S3.3.2). Below this value, it will only indicate 0 (zero).

S1.4 SCR Blocking Voltage

.1 R-U Blocking	0.0 ... 999.9 V
.2 S-V Blocking	0.0 ... 999.9 V
.3 T-W Blocking	0.0 ... 999.9 V

Description:

It indicates the blocking voltage , voltages on the SCRs, with True RMS calculation.

.1 R-U Blocking Blocking voltage R-U.

.2 S-V Blocking Blocking voltage S-V.

.3 T-W Blocking Blocking voltage T-W.

S1.5 Output Power & P.F.

.1 Active	0.0 ... 11700.0 kW
.2 Apparent	0.0 ... 11700.0 kVA
.3 Reactive	0.0 ... 11700.0 kVAr
.4 P. F.	0.0 ... 1.0

Description:

It indicates the average power of the three SSW output phases and the power factor.

- .1 Active** It indicates the active power in kilowatts (kW).
- .2 Apparent** It indicates the apparent power in kilovolt-ampere (kVA).
- .3 Reactive** It indicates the reactive power in Kilovolt-ampere reactive (kVAR).
- .4 P. F.** It indicates the motor power factor.

Accuracy of $\pm 5\%$ with at least 50% of the motor rated current.

WARNING!

The output power will only be indicated when the current is above 20% of the SSW rated current. If it is below 20% of the SSW rated current, then 0.00 (zero) will be indicated.

NOTE!

The motor power factor will only be indicated when the current is above 20% of the SSW rated current. If it is below 20% of the SSW rated current, then 0.00 (zero) will be indicated.

S1.6 P.L.L.

.1 Status	0 ... 1
.2 Frequency	0.0 ... 99.9 Hz
.3 Sequence	0 ... 2

Description:

It indicates the operating status and the variables obtained with the synchronism algorithm of the PLL.

- .1 Status** It indicates the operating status of the PLL's synchronization algorithm.

Indication	Description
0 = Off	PLL is Offline.
1 = Ok	PLL is Ok.

- .2 Frequency** Indicates the line frequency in Hertz (Hz).
- .3 Sequence** It indicates the phase sequence in SSW power input terminals.

Accuracy $\pm 5\%$ of the nominal frequency of the supply network.

Indication	Description
0 = Invalid	Indicates when the PLL is Offline.
1 = RST / 123	Phase sequence R-S-T or L1-L2-L3.
2 = RTS / 132	Phase sequence R-T-S or L1-L3-L2.

NOTE!

The PLL synchronism algorithm will only work with a voltage above 62.5% of the rated motor voltage.

NOTE!

The phase sequence will only be indicated if the R-S, S-T and T-R line voltages are above 62.5% of the motor rated voltage programmed in (C2.1). Otherwise, invalid sequence will be indicated.

S1.7 Motor Torque

.1 Motor %Tn	0.0 ... 999.9 %
--------------	-----------------

Description:

It indicates the motor torque.

.1 Motor %Tn It indicates the motor torque as a percentage of the motor rated torque (Motor Tn %).

The SSW has an algorithm for the motor torque estimation that uses the same principles contained applied by the WEG frequency inverters. This high-tech software allows indicating the torque very close to the actual value.

Accuracy of $\pm 10\%$ of the motor rated torque.



WARNING!

Information regarding the motor rated torque and maximum starting torque are available on the motor manufacturer catalog.



NOTE!

In order that the torque be indicated correctly in S1.7.1, all the parameters related to the motor, from C2.1 to C2.6, must be correctly programmed according to the motor nameplate data.

S1.8 Control Voltage

.1 Input	0.0 ... 999.9 V
.2 +5V	0.0 ... 9.99 V
.3 +12V	0.0 ... 99.9 V
.4 +Vbat	0.0 ... 9.99 V
.5 +48V	0.0 ... 99.9 V

Description:

It indicates internal and external power supply voltage of SSW control board.

.1 Input It indicates the input power supply of electronics.

.2 +5V It indicates the voltage of the internal +5V power supply.

.3 +12V It indicates the voltage of the internal +12V power supply.

.4 +Vbat It indicates the battery voltage of RTC power supply.

.5 +48V It indicates the voltage of the internal +48V power supply.



WARNING!

The voltage limit values are monitored by the protection algorithms. Therefore, if the SSW does not indicate any protection, the voltages are OK.

S2 I/O

It indicates the state of inputs and outputs of control.

S2.1 Digital

.1 Inputs	0 ... 15 Bit
.2 Outputs	0 ... 15 Bit

Description:

It indicates the state of inputs and outputs digital of control.

.1 Inputs It indicates the state of the digital inputs of control, through the numbers 0 (inactive) and 1 (active).

Bit	Value/Description
Bit 0 DI1	0: Inactive. 1: Active.
Bit 1 DI2	0: Inactive. 1: Active.
Bit 2 DI3	0: Inactive. 1: Active.
Bit 3 DI4	0: Inactive. 1: Active.
Bit 4 DI5	0: Inactive. 1: Active.
Bit 5 DI6	0: Inactive. 1: Active.
Bit 6 ... 15 Reserved	Reserved.

.2 Outputs It indicates the state of the digital outputs of control, through the numbers 0 (inactive) and 1 (active).

Bit	Value/Description
Bit 0 DO1	0: Inactive. 1: Active.
Bit 1 DO2	0: Inactive. 1: Active.
Bit 2 DO3	0: Inactive. 1: Active.
Bit 3 ... 15 Reserved	

S2.2 Analog Output

.1 Percent	0.0 ... 100.0 %
.2 Current	0.0 ... 20.0 mA
.3 Voltage	0.0 ... 10.0 V
.4 10 bits	0 ... 1023

Description:

It indicates the analog output value in percentage, current or voltage as programmed.

.1 Percent It indicates the value of analog output in percentage of the maximum.

.2 Current It indicates the value of analog output in mA.

.3 Voltage It indicates the value of analog output in V.

.4 10 bits It indicates the value of analog output in 10 bits. Maximum value of 1023.



NOTE!

The indicated values are according to the analog output programming and observing the motor load values.

The analog output programming: C4.3.

The analog output programming in current or voltage: C4.3.3.

S3 SSW900

Allows viewing the characteristics and states of the SSW.

S3.1 SSW Status

.1 Actual 0 ... 14
 .2 Active Command Source 0 ... 11

Description:

It indicates the SSW present status.

.1 Actual It indicates the actual state of SSW.

This state is also indicated on the upper left corner of the display.

Indication	Description
0 = Ready	Ready to start the motor.
1 = Initial Test	Testing the motor connections and power supply line.
2 = Fault	With fault.
3 = Ramp Up	During the acceleration ramp.
4 = Full Voltage	At full voltage.
5 = Bypass	The bypass contactor is closed.
6 = Reserved	
7 = Ramp Down	During the deceleration ramp.
8 = Braking	Braking is active.
9 = FWD/REV	During the rotation direction change.
10 = Jog	During Jog.
11 = Start Delay	During start delay.
12 = Re-start Delay	During restart delay.
13 = General Disabled	General disabled.
14 = Configuration	During configuration mode: - is initializing the system; - is downloading firmware; - is executing the Oriented Start-up; - HMI copy function in progress; - with incompatibility between parameters.

.2 Active Command Source It indicates the actual origin of the start and stop command source.

Indication	Description
0 = HMI Keys LOC	Active command is HMI keys in Local.
1 = HMI Keys REM	Active command is HMI keys in Remote.
2 = DIx LOC	Active command is Digital Input in Local.
3 = DIx REM	Active command is Digital Input in Remote.
4 = USB LOC	Active command is USB in Local.
5 = USB REM	Active command is USB in Remote.
6 = SoftPLC LOC	Active command is SoftPLC in Local.
7 = SoftPLC REM	Active command is SoftPLC in Remote.
8 = Slot 1 LOC	Active command is Slot 1 in Local.
9 = Slot 1 REM	Active command is Slot 1 in Remote.
10 = Slot 2 LOC	Active command is Slot 2 in Local.
11 = Slot 2 REM	Active command is Slot 2 in Remote.

S3.1.3 Status Word

.1 SSW 0 ... 15 Bit

Description:

Word of SSW status.

.1 SSW Word of SSW status.

Bit	Value/Description
Bit 0 Running	0: The motor is not enabled. 1: The motor is enabled.
Bit 1 Gener. Enabled	0: When it is general disabled by any mean. 1: When it is general enabled by all the means.
Bit 2 JOG	0: The JOG function is inactive. 1: The JOG function is active.
Bit 3 Initial Test	0: None. 1: During the initial tests before the motor starting.
Bit 4 Ramp Up	0: It is not accelerating. 1: During the whole acceleration.
Bit 5 Full Voltage	0: There is no full voltage applied to the motor. 1: Full voltage is being applied to the motor.
Bit 6 Bypass	0: With open bypass. 1: With closed bypass.
Bit 7 Ramp Down	0: It is not decelerating. 1: During the whole deceleration.
Bit 8 Remote	0: Local. 1: Remote.
Bit 9 Braking	0: It is not executing braking. 1: During the braking process.
Bit 10 FWD/REV	0: It is not reverting the rotation direction. 1: During the rotation reversion process.
Bit 11 Reverse	0: Forward rotation. 1: Reverse rotation.
Bit 12 Ton	0: None. 1: Time before start (C5.7.2).
Bit 13 Toff	0: None. 1: Time after stop (C5.7.3).
Bit 14 Alarm	0: The SSW is not in alarm condition. 1: The SSW is in alarm condition. Note: The active alarm codes can be read by means of the menu D2.1.
Bit 15 Fault	0: The SSW is not in fault condition. 1: The SSW is in fault condition. Note: The active fault code can be read by means of the menu D1.1.

S3.1.4 Configuration Mode

.1 Status

0 ... 15 Bit

Description:

It indicates a special condition in which the motor can not be started.

.1 Status It allows the user to identify the source of configuration mode.

Bit	Value/Description
Bit 0 System Initialization	0: OK. 1: Is initializing the system.
Bit 1 Firmware Download	0: OK. 1: Is downloading firmware.
Bit 2 Oriented Start-Up	0: OK. 1: Is executing the Oriented Start-up.
Bit 3 Incompatible	0: OK. 1: With incompatibility between parameters.
Bit 4 Reset Needs	0: OK. 1: Needs reset.
Bit 5 Copy HMI	0: OK. 1: HMI copy function in progress, transferring data between SSW and HMI.
Bit 6 ... 15 Reserved	

In case some of the combinations listed below occurs, the SSW goes to the “Config” state for incompatibility between parameters:

- if rated current out of the range of the SSW model (C9.1);
- if there is more than a GP programmed by DI (C4.1);
- if there is more than a START programmed by DI (C4.1);
- if START programmed by DI, then there must be a STOP by DI (C4.1);
- if STOP programmed by DI, then there must be a START by DI (C4.1);
- if GP with START/STOP by DI (C4.1);
- if there is more than a STOP programmed by DI (C4.1);
- if there is more than a LOC/REM programmed by DI (C4.1);
- if there is more than a SG programmed by DI (C4.1);
- if there is more than a load user 1/2 programmed by DI (C4.1);
- If there is Pump Control with Kick Start (C1.1 e C7.2);
- if there is Torque Control with Kick Start (C1.1 e C7.2);
- if alarm reset of the Thermal Class protection higher than the set (C5.9.4 and C5.9.3);
- if Thermal Class protection + PT100 without PT100 accessory (C5.9.5);
- if alarm reset of the Motor Temperature protection (PT100) higher than the set (C5.8.1.4 e C5.8.1.3).
- If there is DC-Braking with Inside Delta.

NOTE!

When energizing, start the motor or change a configuration with the SSW in “Config” mode for incompatibility between parameters; a message with the cause will show on the display.

S3.2 Software Version

.1 Package	0.0 ... 99.99
------------	---------------

Description:

It indicates the software versions contained in all the microcontrollers installed on the SSW.

.1 Package It indicates the software version contained in the FLASH memory of the microcontroller located on the control board 1. This control board does the interface with the user.

S3.2.2 Details

.1 Control 1 V	0.0 ... 99.99
.2 Control 1 rev.	-32768 ... 32767
.3 Bootloader V	0.0 ... 99.99
.4 Bootloader rev.	-32768 ... 32767
.5 HMI rev.	-32768 ... 32767
.6 Control 2 V	0.0 ... 99.99
.7 Control 2 rev.	-32768 ... 32767
.8 Accessory 1 V	0.0 ... 99.99
.9 Accessory 1 rev.	-32768 ... 32767
.10 Accessory 2 V	0.0 ... 99.99
.11 Accessory 2 rev.	-32768 ... 32767

Description:

It indicates details of the software versions contained in all the microcontrollers installed on the SSW. Ex.: Vx.xx rev.xxxx

.1 Control 1 V It indicates the software version contained in the FLASH memory of the microcontroller located on the control board 1. This control board does the interface with the user.

- .2 Control 1 rev.** It indicates the software revision of the control board 1.
- .3 Bootloader V** It indicates the software version contained in the BootLoader memory of the microcontroller located on the control board 1.
- .4 Bootloader rev.** It indicates the software revision of the BootLoader of the control board 1.
- .5 HMI rev.** Indicates the software revision contained on the HMI.
- .6 Control 2 V** It indicates the software version contained in the FLASH memory of the microcontroller located on the control board 2. This control board has the function of performing the motor control.
- .7 Control 2 rev.** It indicates the software revision of the control board 2.
- .8 Accessory 1 V** It indicates the software version contained in the FLASH memory of the microcontroller located on the accessory 1, if available.
- .9 Accessory 1 rev.** It indicates the software revision contained on the accessory 1.
- .10 Accessory 2 V** It indicates the software version contained in the FLASH memory of the microcontroller located on the accessory 2, if available.
- .11 Accessory 2 rev.** It indicates the software revision contained on the accessory 2.

S3.3 SSW Model

.1 Current	0 ... 6
.2 Voltage	0 ... 1
.3 Control Voltage	0 ... 3
.4 Serial Number	0 ... 4294967295

Description:

It indicates the voltage and current ranges of the SSW model.

- .1 Current** It indicates the current range in which the SSW current model must be configured.

Indication	Description
0 = 10 to 30 A	Enclosure size A, models: 10A, 17A, 24A and 30A.
1 = 45 to 105 A	Enclosure size B, models: 45A, 61A, 85A and 105A.
2 = 130 to 200 A	Enclosure size C, models: 130A, 171A and 200A.
3 = 255 to 412 A	Enclosure size D, models: 255A, 312A, 365A and 412A.
4 = 480 to 670 A	Enclosure size E, models: 480A, 604A and 670A.
5 = 820 to 950 A	Enclosure size F, models: 820A and 950A.
6 = 1100 to 1400 A	Enclosure size G, models: 1100A and 1400A.

NOTE!

The current model of the SSW is programmed in C9.1.1

- .2 Voltage** It indicates the line voltage range of the SSW power section (R/L1, S/L2 and T/L3).

Indication	Description
0 = 220 to 575 V	220 to 575V (-15% to +10%), or 187 to 632 Vac (standard and delta).
1 = 400 to 690 V	400 to 690 V (-15% to +10%), or 340 to 759 Vac (standard).

- .3 Control Voltage** It indicates the phase-neutral voltage of the SSW control (Control Supply 1-2).

Indication	Description
0 = 110 to 240 V	110 to 240 V (-15% to +10%), or 93,5 to 264 Vac.
1 = 110 to 130 V	110 to 130 V (-15% to +10%), or 93,5 to 143 Vac.
2 = 220 to 240 V	220 to 240 V (-15% to +10%), or 176,8 to 264 Vac.
3 = 24 Vcc	24 Vdc

.4 Serial Number It indicates the product serial number.

S3.4 Fan Status

.1 Actual 0 ... 1

Description:

It indicates the state of the power fan.

.1 Actual It indicates the state of the power fan.

Indication	Description
0 = Off	Inactive.
1 = On	Active.

S3.5 Accessories

.1 Slot 1 0 ... 8
.2 Slot 2 0 ... 8

Description:

These parameters identify the accessories that were found installed on the control SLOTS.

.1 Slot 1 Accessory installed in SLOT 1.

.2 Slot 2 Accessory installed in SLOT 2.

Indication	Description
0 = Without	Without accessory.
1 = Anybus-CC	With Anybus-CC communication accessory.
2 = RS-485	With isolated RS-485 communication accessory
3 = PT100	Accessory with 5 input PT100 sensors, for motor overtemperature protection.
4 = I/Os Exp.	With digital input and output expansion accessory.
5 = Profibus	With Profibus communication accessory.
6 = CAN	With DeviceNet or CANopen communication accessory.
7 = Ethernet	With Ethernet communication accessory.
8 = External Current Acqu.	With External Current Acquisition accessory.

NOTE! The accessories can be installed in any slot, but they cannot be duplicated. Only one of a kind can be used.

NOTE! Accessories can not be installed or removed with the SSW energized.

S4 TEMPERATURES

It indicates the temperature of the SCRs heatsink and temperature of the motor, if available.

S4.1 SCRs Temperature

.1 Actual -22 ... 260 °C

Description:

It indicates the temperature of the SCRs heatsink.

.1 Actual It indicates the temperature of the SCRs heatsink.

S4.2 Thermal Class Status

.1 Of Maximum 0.0 ... 100.0 %

Description:

It indicates the status of the motor Thermal Class.

.1 Of Maximum It indicates the Motor Thermal Class Protection en percentage. 0% would be 0°C. 100% would be equivalent to the maximum supported by the motor.

When used the factory default parameter values, C5.9.7.1 = 3 = Class F 155°C, C5.9.7.2 = 60°C and C5.9.7.3 = 40°C, as IEC 60947-4-2 standard:

0.0% would be 0°C.

25.8% would be the motor cold at ambient temperature C5.9.7.3 = 40°C.

64.5% would be the motor hot working at full regime C5.9.7.3 = 40°C + C5.9.7.2 = 60°C.

100.0% would be the motor insulation class C5.9.7.1 = 3 = Class F 155°C.

For more details, see Figure 11.23.

S4.3 Motor Temperature

.1 Channel 1	-20 ... 260 °C
.2 Channel 2	-20 ... 260 °C
.3 Channel 3	-20 ... 260 °C
.4 Channel 4	-20 ... 260 °C
.5 Channel 5	-20 ... 260 °C
.6 Channel 6	-20 ... 260 °C

Description:

It indicates the motor temperature obtained by accessory PT100.

.1 Channel 1 It indicates the temperature of Channel 1.

.2 Channel 2 It indicates the temperature of Channel 2.

.3 Channel 3 It indicates the temperature of Channel 3.

.4 Channel 4 It indicates the temperature of Channel 4.

.5 Channel 5 It indicates the temperature of Channel 5.

.6 Channel 6 It indicates the temperature of Channel 6.

NOTE!

For this function you must use the accessory PT100.

S5 COMMUNICATIONS

HMI monitoring parameters of the communication interfaces.

For a detailed description, refer to the Anybus-CC, CANopen, DeviceNet and Modbus RTU User's Manuals of the SSW according to the interface used.

S5.1 Status Word

.1 SSW 0 ... 15 Bit

Description:

Word of SSW status.

.1 SSW Word of SSW status.

Bit	Value/Description
Bit 0 Running	0: The motor is not enabled. 1: The motor is enabled.
Bit 1 Gener. Enabled	0: When it is general disabled by any mean. 1: When it is general enabled by all the means.
Bit 2 JOG	0: The JOG function is inactive. 1: The JOG function is active.
Bit 3 Initial Test	0: None. 1: During the initial tests before the motor starting.
Bit 4 Ramp Up	0: It is not accelerating. 1: During the whole acceleration.
Bit 5 Full Voltage	0: There is no full voltage applied to the motor. 1: Full voltage is being applied to the motor.
Bit 6 Bypass	0: With open bypass. 1: With closed bypass.
Bit 7 Ramp Down	0: It is not decelerating. 1: During the whole deceleration.
Bit 8 Remote	0: Local. 1: Remote.
Bit 9 Braking	0: It is not executing braking. 1: During the braking process.
Bit 10 FWD/REV	0: It is not reverting the rotation direction. 1: During the rotation reversion process.
Bit 11 Reverse	0: Forward rotation. 1: Reverse rotation.
Bit 12 Ton	0: None. 1: Time before start (C5.7.2).
Bit 13 Toff	0: None. 1: Time after stop (C5.7.3).
Bit 14 Alarm	0: The SSW is not in alarm condition. 1: The SSW is in alarm condition. Note: The active alarm codes can be read by means of the menu D2.1.
Bit 15 Fault	0: The SSW is not in fault condition. 1: The SSW is in fault condition. Note: The active fault code can be read by means of the menu D1.1.

S5.2 Command Word

.1 Dlx	0 ... 15 Bit
.2 HMI Key	0 ... 15 Bit
.3 USB	0 ... 15 Bit
.4 SoftPLC	0 ... 15 Bit
.5 Slot1	0 ... 15 Bit
.6 Slot2	0 ... 15 Bit

Description:

Command word of all sources of the SSW. The RUN/STOP and JOG commands of the sources which are not active will be reset.

.1 Dlx Command word via digital inputs.

Bit	Value/Description
Bit 0 Start/Stop	0 : stopping by ramp. 1 : starting ramp.
Bit 1 Gener. Enabled	0 : general disable. 1 : general enable.
Bit 2 JOG	0 : no JOG. 1 : with JOG.
Bit 3 FWD/REV	0 : clockwise CW. 1 : counterclockwise CCW.
Bit 4 LOC/REM	0 : local. 1 : remote.
Bit 5 ... 6 Reserved	
Bit 7 Reset	0 → 1 : execute fault reset (if a fault is active). Note: Only in the 0 to 1 transition command.
Bit 8 Brake	0 : braking is off. 1 : braking is on.
Bit 9 Emergency Start	0 : stopping in emergency start. 1 : starting in emergency start.
Bit 10 ... 15 Reserved	

.2 HMI Key Command word via HMI keys.

.3 USB Command word via USB.

.4 SoftPLC Command word via SoftPCL.

.5 Slot1 Control word via any communication accessory connected to Slot 1.

.6 Slot2 Command word via any communication accessory connected to Slot 2.

Bit	Value/Description
Bit 0 Start/Stop	0 : stopping by ramp. 1 : starting by ramp.
Bit 1 Gener. Enabled	0 : general disable. 1 : general enable.
Bit 2 JOG	0 : no JOG. 1 : with JOG.
Bit 3 FWD/REV	0 : clockwise CW. 1 : counterclockwise CCW.
Bit 4 LOC/REM	0 : local. 1 : remote.
Bit 5 ... 6 Reserved	
Bit 7 Reset	0 → 1 : execute fault reset (if a fault is active). Note: Only in the 0 to 1 transition command.
Bit 8 ... 15 Reserved	



NOTE!

If the RUN/STOP and JOG commands are by a certain source and it is active, only these commands can be viewed in S5.2. For security reasons, all the other commands of the other sources which are not active will be reset.

S5.3 Value for Outputs

.1 DO Value 0 ... 15 Bit

Description:

Value for digital and analog outputs via serial communication.

.1 DO Value Value for the digital outputs via network interfaces.

Bit	Value/Description
Bit 0 DO1	0: Inactive. 1: Active.
Bit 1 DO2	0: Inactive. 1: Active.
Bit 2 DO3	0: Inactive. 1: Active.
Bit 3 ... 15 Reserved	

S5.3.2 Value for AO

.1 AO in 10 bits 0 ... 1023

Description:

Value for the analog output via network interfaces.

.1 AO in 10 bits Value for the analog output via network interfaces: 0...1023. 0=0% and 1023=100%.

S5.4 RS485 Serial

.1 Interface Status 0 ... 2
 .2 Received Telegram 0 ... 65535
 .3 Transmitted Telegram 0 ... 65535
 .4 Telegram with Error 0 ... 65535
 .5 Reception Errors 0 ... 65535

Description:

Status for RS485 accessory, and the protocols using this interface.

.1 Interface Status Identify whether the RS485 serial interface board is properly installed, and whether the serial communication presents errors.

Indication	Description
0 = Off	Inactive serial interface. The RS485 interface accessory is not installed.
1 = On	The RS485 interface accessory is installed and detected.
2 = Timeout Error	Serial interface is active, but a serial communication alarm or fault is detected - alarm A128 / fault F128.

.2 Received Telegram Cyclic counter that is incremented every time a telegram is received.

.3 Transmitted Telegram Cyclic counter that is incremented every time a telegram is transmitted.

.4 Telegram with Error It shows the number of messages received with incorrect error check field (i.e.: CRC, Checksum).

.5 Reception Errors It shows the number of bytes received with other communication errors.



NOTE!

The contactors are cyclic, that is, above 65535 they return to 0.

S5.5 Anybus-CC

.1 Identification	0 ... 25
.2 Comm. Status	0 ... 8

Description:

Status of the Anybus communication accessory and the protocols that use this interface.

.1 Identification It allows identifying the connected Anybus module.

Indication	Description
0 = Disabled	Communication module not installed.
1 ... 15 = Reserved	
16 = Profibus DP	Profibus DP module.
17 = DeviceNet	DeviceNet Module.
18 = Reserved	
19 = EtherNet/IP	EtherNet/IP module.
20 = Reserved	
21 = Modbus TCP	Modbus TCP module.
22 = Reserved	
23 = PROFINET IO	PROFINET IO module.
24 ... 25 = Reserved	

.2 Comm. Status It informs the communication module status.

Indication	Description
0 = Setup	Module identified, waiting for configuration data (automatic).
1 = Init	Module executing the interface initialization (automatic).
2 = Wait Comm	Module initialized, but without communication with the network master.
3 = Idle	Communication with the network master established, but in idle or programming mode.
4 = Data Active	Communication with the network master established, and I/O data being communicated successfully. "Online".
5 = Error	Not available.
6 = Reserved	
7 = Exception	Serious error on the communication interface. The interface requires reinitialization.
8 = Access Error	Access error between the equipment and Anybus interface. Requires interface reset.

S5.6 Configuration Mode

.1 Status	0 ... 15 Bit
.2 Control	0 ... 15 Bit

Description:

It indicates a special condition in which the motor can not be started.

.1 Status It allows the user to identify the source of configuration mode.

Bit	Value/Description
Bit 0 System Initialization	0: OK. 1: Is initializing the system.
Bit 1 Firmware Download	0: OK. 1: Is downloading firmware.
Bit 2 Oriented Start-Up	0: OK. 1: Is executing the Oriented Start-up.
Bit 3 Incompatible	0: OK. 1: With incompatibility between parameters.
Bit 4 Reset Needs	0: OK. 1: Needs reset.
Bit 5 Copy HMI	0: OK. 1: HMI copy function in progress, transferring data between SSW and HMI.
Bit 6 ... 15 Reserved	

In case some of the combinations listed below occurs, the SSW goes to the “Config” state for incompatibility between parameters:

- if rated current out of the range of the SSW model (C9.1);
- if there is more than a GP programmed by DI (C4.1);
- if there is more than a START programmed by DI (C4.1);
- if START programmed by DI, then there must be a STOP by DI (C4.1);
- if STOP programmed by DI, then there must be a START by DI (C4.1);
- if GP with START/STOP by DI (C4.1);
- if there is more than a STOP programmed by DI (C4.1);
- if there is more than a LOC/REM programmed by DI (C4.1);
- if there is more than a SG programmed by DI (C4.1);
- if there is more than a load user 1/2 programmed by DI (C4.1);
- If there is Pump Control with Kick Start (C1.1 e C7.2);
- if there is Torque Control with Kick Start (C1.1 e C7.2);
- if alarm reset of the Thermal Class protection higher than the set (C5.9.4 and C5.9.3);
- if Thermal Class protection + PT100 without PT100 accessory (C5.9.5);
- if alarm reset of the Motor Temperature protection (PT100) higher than the set (C5.8.1.4 e C5.8.1.3).
- If there is DC-Braking with Inside Delta.

NOTE!

When energizing, start the motor or change a configuration with the SSW in “Config” mode for incompatibility between parameters; a message with the cause will show on the display.

.2 Control It allows the user to change the SSW operating mode via serial communication.

Bit	Value/Description
Bit 0 Abort Startup	0: do not abort the oriented Start-up. 1: abort the oriented Start-up.
Bit 1 ... 15 Reserved	

S5.7 CANopen/DeviceNet

.1 CAN Controller Status	0 ... 6
.2 Received Telegram	0 ... 65535
.3 Transmitted Telegram	0 ... 65535
.4 Bus Off Counter	0 ... 65535
.5 Lost Messages	0 ... 65535
.6 CANopen Comm. Status	0 ... 5
.7 CANopen Node State	0 ... 4
.8 DNet Network Status	0 ... 5
.9 DeviceNet Master Status	0 ... 1

Description:

Status of the CAN communication accessory and the protocols that use this interface.

.1 CAN Controller Status It allows identifying if the CAN interface board is properly installed and if the communication presents errors.

Indication	Description
0 = Disabled	Inactive CAN interface. It occurs when CAN protocol is not programmed at C8.4.1.
1 = Auto-baud	CAN controller is trying to detect baud rate of the network (only for DeviceNet communication protocol).
2 = CAN Enabled	CAN interface is active and without errors.
3 = Warning	CAN controller has reached the warning state.
4 = Error Passive	CAN controller has reached the error passive state.
5 = Bus Off	CAN controller has reached the bus off state.
6 = No Bus Power	CAN interface does not have power supply between the pins 1 and 5 of the connector.

.2 Received Telegram This parameter works as a cyclic counter that is incremented every time a CAN telegram is received. It informs the operator if the device is being able to communicate with the network.

.3 Transmitted Telegram This parameter works as a cyclic counter that is incremented every time a CAN telegram is transmitted. It informs the operator if the device is being able to communicate with the network.

.4 Bus Off Counter It is a cyclic counter that indicates the number of times the device entered the bus off state in the CAN network.

.5 Lost Messages It is a cyclic counter that indicates the number of messages received by the CAN interface, but could not be processed by the device. In case that the number of lost messages is frequently incremented, it is recommended to reduce the baud rate used in the CAN network.

NOTE! This counter is reset every time the device is switched off, a reset is performed or the parameter maximum limit is reached.

.6 CANopen Comm. Status It indicates the board state regarding the CANopen network, informing if the protocol has been enabled and if the error control service is active (Node Guarding or Heartbeat).

Indication	Description
0 = Disabled	CANopen protocol disabled.
1 = Reserved	
2 = Comm. Enabled	Communication enabled.
3 = ErrorCtrl.Enab	Communication enabled and error control service enabled (Node Guarding/Heartbeat).
4 = Guarding Error	Node Guarding error occurred.
5 = HeartbeatError	Heartbeat error occurred.

.7 CANopen Node State It operates as a slave of the CANopen network, and as such element it has a state machine that controls its behavior regarding the communication. This parameter indicates in which state the device is.

Indication	Description
0 = Disabled	CANopen protocol disabled.
1 = Initialization	Communication with the device is not possible during this stage, which is concluded automatically.
2 = Stopped	Only the NMT object is available.
3 = Operational	All the communication objects are available.
4 = PreOperational	It is already possible to communicate with the slave but its PDOs are not yet available for operation.

.8 DNet Network Status It indicates the status of the DeviceNet network.

Indication	Description
0 = Offline	Device without power supply or not online. Communication cannot be established.
1 = OnLine,NotConn	Device online, but not connected. The slave has successfully completed the MacID verification procedure. This means that the configured baud rate is correct (or it has been detected correctly in case of autobaud) and that there are no other network nodes with the same address. However, there is no communication with the master yet in this stage.
2 = OnLine,Conn	The device is operational and in normal conditions. The master has allocated a set of I/O type connections with the slave. In this stage the effective exchange of data by means of I/O type connections occurs.
3 = Conn.Timed-out	One or more I/O type connections have expired.
4 = Link Failure	It indicates that the slave was not able to enter the network due to addressing problems or due to the occurrence of bus off. Make sure the configured address is not used by other device, verify if the chosen baud rate is correct and make sure there are no installation problems.
5 = Auto-Baud	The equipment is executing the autobaud mechanism.

.9 DeviceNet Master Status It indicates the DeviceNet network master status. It may be in operation mode (Run) or in configuration mode (Idle).

Indication	Description
0 = Run	Reading and writing telegrams are processed normally and updated by the master.
1 = Idle	Only the reading telegrams from the slaves are updated by the master. Writing, in this case, remains disabled.



NOTE!

When communication is disabled this parameter does not represent the actual state of the master.

S5.9 Bluetooth

.1 MAC Address 00:00:00:00:00:00 ... FF:FF:FF:FF:FF:FF

Description:

The following configurations are available for products that have HMI interface with integrated bluetooth technology.

.1 MAC Address Bluetooth Device MAC Address is a unique 48-bit identifier assigned to each Bluetooth device by the manufacturer.

S6 SOFTPLC

Parameters related to SoftPLC. For more details, refer to the Help text of WPS (WEG Programming Suite) Software.

S6.1 SoftPLC Status

.1 Actual 0 ... 4

Description:

Status in which the SoftPLC is. If no applications are installed, the other parameters will not be displayed on the HMI.

.1 Actual It allows the user to visualize the SoftPLC status.

If this parameter presents the option 2 (Incompatible App.), it indicates that the version that has been loaded is not compatible with the current SSW firmware.

In this case, it is necessary to recompile the project in the WPS considering the new SSW version, and to download it again.

Indication	Description
0 = No Application	No application saved.
1 = Install. App.	Installing application.
2 = Incompat. App.	Version of the application that was saved in memory is not compatible with the current SSW firmware.
3 = App. Stopped	Application is not running.
4 = App. Running	Application is running.

S6.2 Scan Cycle Time

.1 Actual 0 ... 65535 ms

Description:

Software application execution time.

.1 Actual It is the software application execution time. The largest the application, the longest the execution time tends to be.

S6.3 Value for Outputs

.1 DO Value 0 ... 15 Bit

Description:

Value for the digital and analog outputs via SoftPLC.

.1 DO Value Value for the digital outputs via SoftPLC.

Bit	Value/Description
Bit 0 DO1	0: Inactive. 1: Active.
Bit 1 DO2	0: Inactive. 1: Active.
Bit 2 DO3	0: Inactive. 1: Active.
Bit 3 ... 15 Reserved	

S6.3.2 AO Value

.1 AO in 10 bits 0 ... 1023

Description:

Value for the analog outputs via SoftPLC.

.1 AO in 10 bits Value for the analog outputs via SoftPLC: 0...1023. 0=0% e 1023=100%.

S6.4 Parameter

.1 User #1	-10000 ... 10000
to	
.50 User #50	-10000 ... 10000

Description:

They are usage parameters defined by the user via WPS software. The user can also configure those parameters.

.1 User #1 to .50 User #50 They consist of parameters with functions defined by the user by means of the WPS software. It is possible for the user to configure these parameters.



NOTE!

The user parameters set to writing (Configurations - C11.3.X) are always retentive. The user parameters set to Read Only (Status - S6.4.X) are not retentive.

10 D DIAGNOSTICS

It allows viewing variables and events that may help diagnose problems or improve the SSW operation.

D1 FAULT

Faults occurred.

The faults occurred on the SSW are registered in this group.

D1.1 Actual

.1 Fxxx	0 ... 999
---------	-----------

Description:

Present fault. If any fault is active, it is indicated in actual fault. If it is not active, 0 is indicated.

The faults operates by disabling the motor. They can only be reset with a reset command or by de-energizing the SSW control.

.1 **Fxxx** Actual fault. If any fault is active, it is indicated.

D1.2 Fault History

The fault history records the faults occurred on the SSW, together with other relevant information for the fault interpretation, such as, date, hour, motor current, etc.

These data are saved in standard CSV (Comma-Separated Values) format, and can be read via WPS or serial communication.



NOTE!

In case some fault occurs simultaneously with the energization followed by a de-energization of the SSW, the information regarding this fault, such as date, hour, etc., may contain invalid information.

D2 ALARMS

Alarms occurred.

The alarms occurred on the SSW are recorded in this group.

D2.1 Actual

.1 Axxx 1	0 ... 999
.2 Axxx 2	0 ... 999
.3 Axxx 3	0 ... 999
.4 Axxx 4	0 ... 999
.5 Axxx 5	0 ... 999

Description:

Present alarms. If any alarm is active, it is indicated. If it is not active, 0 is indicated.

The alarms operate by indicating their occurrence on the HMI and in the SSW status word. They are automatically reset when the alarm condition ceases existing.

The alarms are placed in a line, which may indicate up to 5 alarms simultaneously. Whenever an alarm operates, it is placed in the 5th position, being moved to the positions below if they are empty.

Visually on the HMI, if only one alarm occurs, it will be in the last position (Alarm 1).

- .1 Axxx 1** Last position of alarm indication.
- .2 Axxx 2** Fourth position of alarm indication.
- .3 Axxx 3** Third position of alarm indication.
- .4 Axxx 4** Second position of alarm indication.
- .5 Axxx 5** First position of alarm indication.

D2.2 Alarm History

The alarm history records the alarms occurred on the SSW, together with other relevant information for the fault interpretation, such as, date, hour, motor current, etc.

These data are saved in standard CSV (Comma-separated values) format. They can be read via WPS or serial communication.



NOTE!

In case some alarm occurs simultaneously with the energization followed by a de-energization of the SSW, the information regarding this alarm, such as date, hour, etc., may contain invalid information.

D3 EVENTS

Events occurred.

The events occurred on the SSW are recorded in this group.

These data are saved in standard CSV (Comma-Separated Values) format. The HMI shows the last alarms occurred. To access the complete file, the WPS should be used.



NOTE!

In case some alarm occurs simultaneously with the energization followed by a de-energization of the SSW, the information regarding this alarm, such as date, hour, etc., may contain invalid information.

D4 MOTOR ON

It shows different values saved with the motor energized.

D4.1 Start Current

.1 Maximum	0.0 ... 14544.0 A
.2 Average	0.0 ... 14544.0 A

Description:

Saves the current values during the motor start.

- .1 Maximum** Saves the maximum current value during the start.

.2 Average It saves the average starting current value. The value is reset at the beginning of every start.

These values go to zero at the beginning of each start, and they are not kept when the SSW is de-energized.

It does not record currents of the Jog function.

D4.2 Real Start Time

.1 Actual	0 ... 999 s
.2 Final	0 ... 999 s

Description:

It stores the real starting time.

The real starting time is the time necessary for the motor to reach its rated speed. This period depends on the starting parameter settings and on the load conditions. The time set in C1.3, even for voltage ramp, is not the real starting time.

For instance, a motor without load is able to reach its rated speed with lower voltages, and the C1.3 time is the period it takes for the SSW to apply 100 % of the supply line voltage on the motor.

.1 Actual It shows the value of the present starting time. This value is saved in the end value D.4.2.2 when it reaches the end of the start; then it goes to 0.

.2 Final End value saved after the motor start.

The value of the real starting time is not kept when the SSW is de-energized. These values go to zero at the beginning of each start.

D4.3 Current Full Voltage

.1 Maximum	0.0 ... 14544.0 A
------------	-------------------

Description:

It saves the highest current value while the motor is at full voltage or with the bypass closed.

.1 Maximum It saves the highest current value during the time the motor is at full voltage.

These values are kept even when the power is removed from the SSW. By setting C10.3.1 = 5, these values are reset to zero.

D4.4 Main Line Voltage

.1 Maximum	0.0 ... 999.9 V
.2 Minimum	0.0 ... 999.9 V

Description:

It saves the line voltage values with the motor in operation.

.1 Maximum It saves the highest line voltage value with the motor in operation.

.2 Minimum It stores the lowest line voltage value with the motor in operation.

These values are kept even when the power is removed from the SSW. By setting C10.3.1 = 5, these values are reset to zero.

D4.5 Main Line Frequency

.1 Maximum	0.0 ... 99.9 Hz
.2 Minimum	0.0 ... 99.9 Hz

Description:

It saves the line frequency values with the motor in operation.

.1 Maximum It saves the highest line frequency value with the motor in operation.

.2 Minimum It saves the lowest line frequency value with the motor in operation.

These values are kept even when the power is removed from the SSW. By setting C10.3.1 = 5, these values are reset to zero.

D4.6 kWh Counter

.1 Total	0.0 ... 214748364.7 kWh
----------	-------------------------

Description:

It indicates the energy consumed by the motor, in kWh.

.1 Total It indicates the energy consumed by the motor, in kWh.

This value is kept even when the power is removed from the SSW. By setting C10.3.1 = 5, this value is reset to zero.

D4.7 Number Start

.1 Total	0 ... 65535
----------	-------------

Description:

It saves the total number of starts executed by the SSW.

In order to be considered a start, the motor must initiate the starting after the initial test, i.e., the line and motor connections must be correct.

.1 Total It saves the total number of starts executed by the SSW.

This value is kept even when the power is removed from the SSW.

D5 TEMPERATURES

It saves the highest SCR and motor temperatures, if available.

D5.1 SCRs Maximum

.1 Total	-22 ... 260 °C
----------	----------------

Description:

It saves the highest SCRs temperature value.

.1 Total It saves the highest SCRs temperature value.

This value is kept even when the power is removed from the SSW. By setting C10.3.1 = 6, this value is reset to zero.

D5.2 Motor Maximum

.1 Channel 1	-20 ... 260 °C
.2 Channel 2	-20 ... 260 °C
.3 Channel 3	-20 ... 260 °C
.4 Channel 4	-20 ... 260 °C
.5 Channel 5	-20 ... 260 °C
.6 Channel 6	-20 ... 260 °C

Description:

It saves the highest motor temperature values.

- .1 Channel 1** It saves the highest motor temperature value registered in the channel 1.
- .2 Channel 2** It saves the highest motor temperature value registered in the channel 2.
- .3 Channel 3** It saves the highest motor temperature value registered in the channel 3.
- .4 Channel 4** It saves the highest motor temperature value registered in the channel 4.
- .5 Channel 5** It saves the highest motor temperature value registered in the channel 5.
- .6 Channel 6** It saves the highest motor temperature value registered in the channel 6.

These values are kept even when the power is removed from the SSW. By setting C10.3.1 = 5, these values are reset to zero.

NOTE!

The use of this function requires the PT100 accessory.

D6 HOURS CONTROL
D6 Hours Control

.1 Powered	0 ... 4294967295 s
.2 Enabled	0 ... 4294967295 s
.3 Fan ON	0 ... 4294967295 s

Description:

It saves the total hours of some SSW conditions.

- .1 Powered** It indicates the total number of hours that the SSW was powered.
- .2 Enabled** It indicates the total number of hours that the SSW has run.
- .3 Fan ON** It indicates the total number of hours that the fan has run.

These values are kept even when the power is removed from the SSW. By setting C10.3.1 =7, the values of D6.2 and D6.3 are reset to zero.

D7 CHANGED PARAMETERS

This menu allows visualizing all the parameters with contents different from the factory settings.

11 C CONFIGURATIONS

This menu allows the programming of all SSW configuration parameters.

C1 STARTING AND STOPPING

It allows configuring the motor operation and start and stop type.

C1 Starting and Stopping

C1.1 Types of Control

Range:	0 ... 6	Default: 1
Properties:	Stopped	

Description:

The SSW has seven starting control types, in order to better match all application requirements.

Indication	Description
0 = Voltage Ramp	Starting with voltage ramp.
1 = Voltage Ramp + Current Limit	Starting with voltage ramp and current limit.
2 = Current Limit	Starting with current limit.
3 = Current Ramp	Starting with current ramp.
4 = Pump Control	Starting with pump control.
5 = Torque Control	Starting with torque control.
6 = D.O.L. SCR	Starting with direct on line (D.O.L.) SCRs.

Starting with voltage ramp (A):

This is usually the most used method.

The SSW imposes the voltage to the motor, initially without any kind of voltage or current feedback applied to the motor. It is applied to loads with lower initial torque or with quadratic torque.

This control type can be used as an initial operation test.

Starting with voltage ramp + current limit (B):

The SSW imposes the voltage to the motor, initially without any kind of voltage or current feedback applied to the motor, until reaching the current limit set in C1.7, remaining so until the end of the motor start.

It is applied to loads with lower initial torque or with quadratic torque.

Starting with current limit (B): The maximum current is limited during the starting, being adjusted according to the application needs. It is applied to loads with higher initial torque or with constant torque.

This type of control is used to adapt the starting to the supply line capacity limits.

Starting with current ramp (C): The maximum current is also limited during the starting, however, lower or higher current limits can be adjusted for the starting beginning.

It is applied to loads with lower or higher initial torque. It can replace the kick start function for loads with higher initial torque.

It can fully replace the voltage ramp, with lower initial current and higher start end current, when used with quadratic load, with the advantage of controlled current throughout the starting.

This type of control is used to adapt the starting to the supply line capacity limits.

Starting with pump control (C): It is optimized to provide the torque necessary to smoothly start and stop centrifugal hydraulic pumps.

It has a special algorithm for centrifugal pumps, which are loads with quadratic torque. This special algorithm is designed to minimize water hammer and pressure overshoots that could break or wear out excessively the hydraulic pipes.

Starting with torque control: The SSW has a high performance and very flexible torque control algorithm to meet the needs of any application, for starting as well as stopping the load smoothly.

Torque control with 1 setting point (B): It allows adjusting a constant starting torque limit.

Torque control with 2 setting points (C): It allows adjusting the starting torque limit in a linear ramp.

Torque control with 3 setting points (D): It allows adjusting a starting torque limit curve with 3 points, initial, intermediate and end. It makes it possible to start quadratic loads, among others.

Starting with Direct on Line D.O.L. SCR (A): The SSW imposes 100% of voltage on the motor without any kind of voltage or current feedback applied to the motor.



NOTE!

The method Direct on Line D.O.L. SCR is applied only in special cases, where is required 100% of voltage on the motor during the motor starting.

Degree of difficulty of the control types:

- (A) Very easy to adjust and program;
- (B) Easy to adjust and program;
- (C) It requires some knowledge of the load for adjusting and programming;
- (D) It requires requires extensive knowledge of the load for adjusting and programming.



NOTE!

The control types are disposed according to the using and programming degree of difficulty. Therefore, begin using the easier control modes.

The next table presents the relationship between the adopted type of starting control and the automatically selected stopping control.

STARTING	STOPPING			
	Voltage Ramp	Pump Control	Torque Control	Direct Stop
Voltage Ramp	X			X
Voltage Ramp + Current Limit	X			X
Current Limit	X			X
Current Ramp	X			X
Pump Control		X		X
Torque Control			X	X
D.O.L. SCR				X

Table 11.1: Available deceleration methods as a function of the starting technique.



NOTE!

When there is the need of limiting the starting current, then the current limit or the current ramp must be used.

The Figure 11.1 shows the programming sequence necessary for each control type.



NOTE!

To facilitate the programming and setting of the control type, the Programming Assistant can be used (A.1). All the parameters of this sequence must be checked and adjusted, if necessary, before starting the motor.

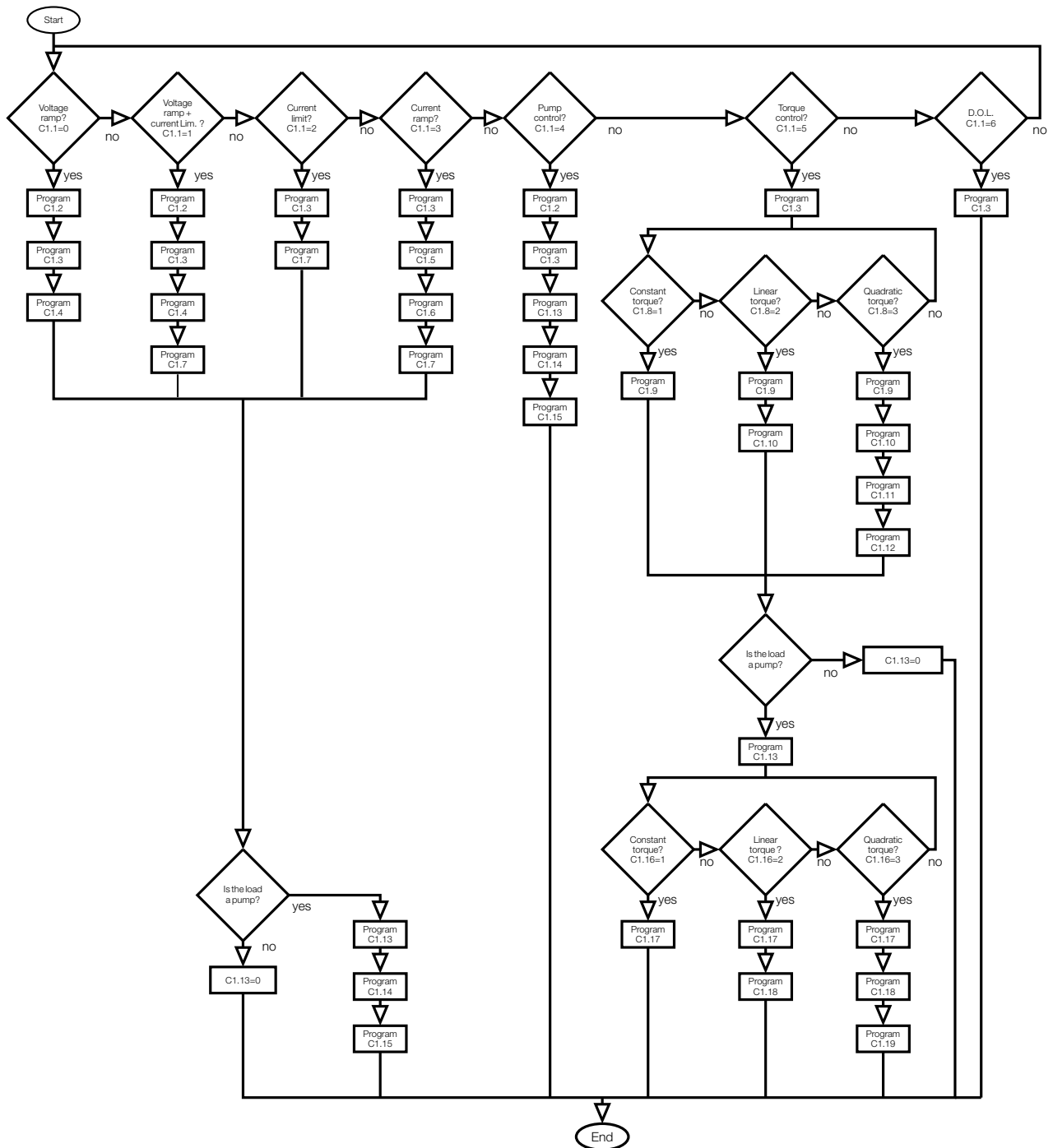

Figure 11.1: Programming sequence of the control type.

C1 Starting and Stopping

C1.2 Initial Start Voltage

Range: 25 ... 90 %

Default: 30

Properties: Stopped

Description:

It is used with the control types Voltage Ramp and Pump Control, C1.1 = 0 or 2.

It adjusts the initial start voltage as a percentage of the nominal voltage (%Un) that will be applied to the motor, according to the Figure 11.2.

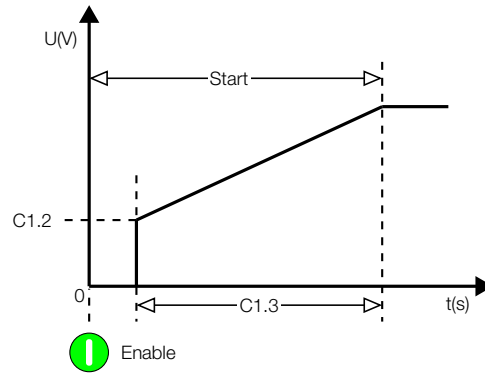

Figure 11.2: Initial Voltage.



NOTE!

When a control type different from Pump Control is selected, then the initial start voltage will be attenuated depending on the limit imposed by that control.



NOTE!

When Voltage Ramp + Current Limit is selected, the value of the initial voltage will be attenuated considering the Current Limit. However, with high initial voltage values and low current limit values, current “overshoots” may occur at the initial moment of the start.

C1 Starting and Stopping

C1.3 Maximum Start Time

Range: 1 ... 999 s

Default: 20

Properties: Stopped

Description:

When the SSW is programmed for the control types Voltage Ramp or Pump Control, this becomes the time for the voltage increase.

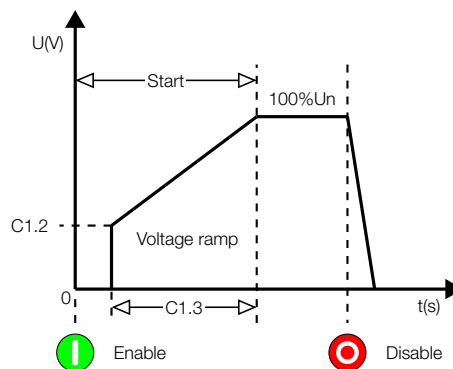

Figure 11.3: Acceleration ramp by Voltage Ramp.



NOTE!

The time programmed in C1.3 is not the exact motor acceleration time, but the voltage ramp time or the maximum allowed start time. The motor acceleration time depends on the motor characteristics, as well as on the load characteristics.

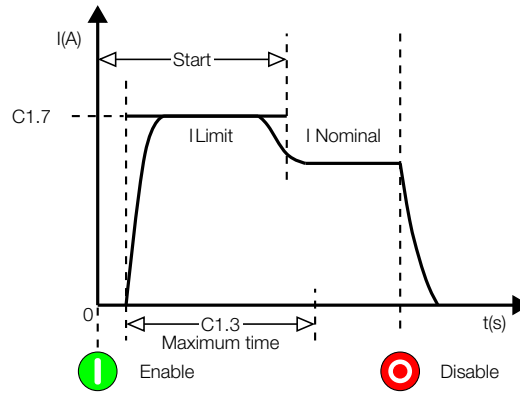

Figure 11.4: Acceleration ramp by Current Limit.

When the SSW is programmed for the control types Voltage Ramp + Current Limit, Current Limit, Torque Control or Current Ramp, this parameter sets the maximum start time and working as a protection against locked rotor.

C1 Starting and Stopping		
C1.4 Start End Detection		
Range:	0 ... 1	Default: 1
Properties:	Stopped	

Description:

It allows applying full voltage to the motor as soon as it reaches its rated speed, before the end of the period programmed in C1.3, when starting with voltage ramp.

The acceleration end is detected when S1.3.2 reaches 95% of the supply line voltage, S1.2.6. This function is used to prevent the motor from operating at rated speed with voltage lower than the nominal, thus avoiding possible SCR burning due to synchronism loss in this condition.

Indication	Description
0 = Time	Using ramp time, Maximum Start Time C1.3.
1 = Automatic	Detects that the motor has reached its rated speed.

C1 Starting and Stopping		
C1.5 Initial Current Ramp		
Range:	150 ... 500 %	Default: 150
Properties:	Stopped	

Description:

It makes it possible to program a current limit ramp to allow starting loads with higher or lower starting torque, or quadratic loads, replacing the voltage ramp.

The current limit initial value is given by C1.5, the end value by C1.7 and the time by C1.7, according to the Figure 11.5.

C1 Starting and Stopping		
C1.6 Current Ramp Time		
Range:	1 ... 99 %	Default: 20
Properties:	Stopped	

Description:

It is used by the Current Ramp control, C1.1 = 3. It makes it possible to program the time until the end of the current ramp, as a percentage of C1.3.

After the time programmed in C1.6 has elapsed, the current limit is set by C1.7.

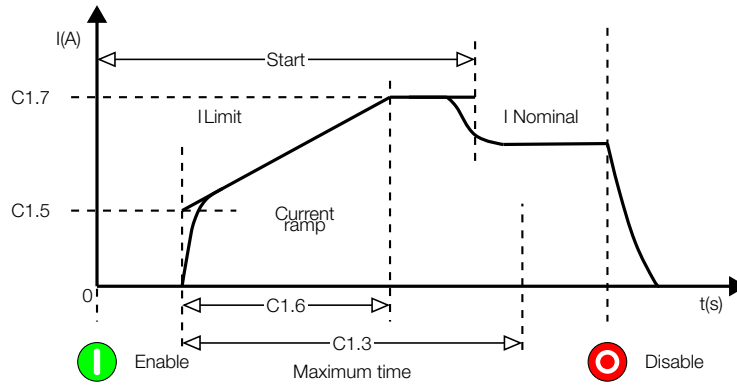

Figure 11.5: Starting with current ramp and lower initial value.

Small C1.6 values in the Figure 11.5 allow smoothening the starting initial moments. Commonly used on driving motors with power from generators.

Big C1.6 values in the Figure 11.5 allow the starting of quadratic loads such as hydraulic pumps and fans.

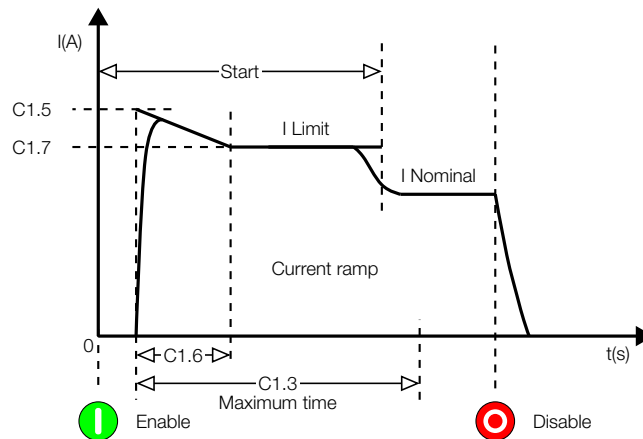

Figure 11.6: Starting with current ramp and higher initial value.

The initial C1.5 current value programmed in the Figure 11.6 is used to provide a higher initial torque, in order to overcome loads with resistant torque.

C1 Starting and Stopping		
C1.7 Current Limit		
Range:	150 ... 500 %	Default: 300
Properties:	Stopped	

Description:

It defines the maximum current during the motor starting, as a percentage of the motor rated current adjusted in C2.2.

If the current limit is reached during the motor starting, the SSW maintains the current in that limit until the motor achieves the starting end.

If the current limit is not reached, the motor will start immediately.

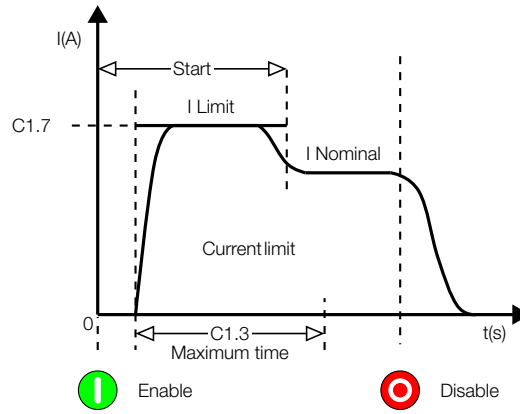

Figure 11.7: Current Limit.

C1 Starting and Stopping

C1.8 Start Torque Chara.

Range: 1 ... 3

Default: 1

Properties: Stopped

Description:

It allows choosing which torque profile the SSW will follow during the motor starting.

Three torque limit profiles are available, which make it possible to start any type of load, constant or 1 point, linear or 2 points and quadratic or 3 points.

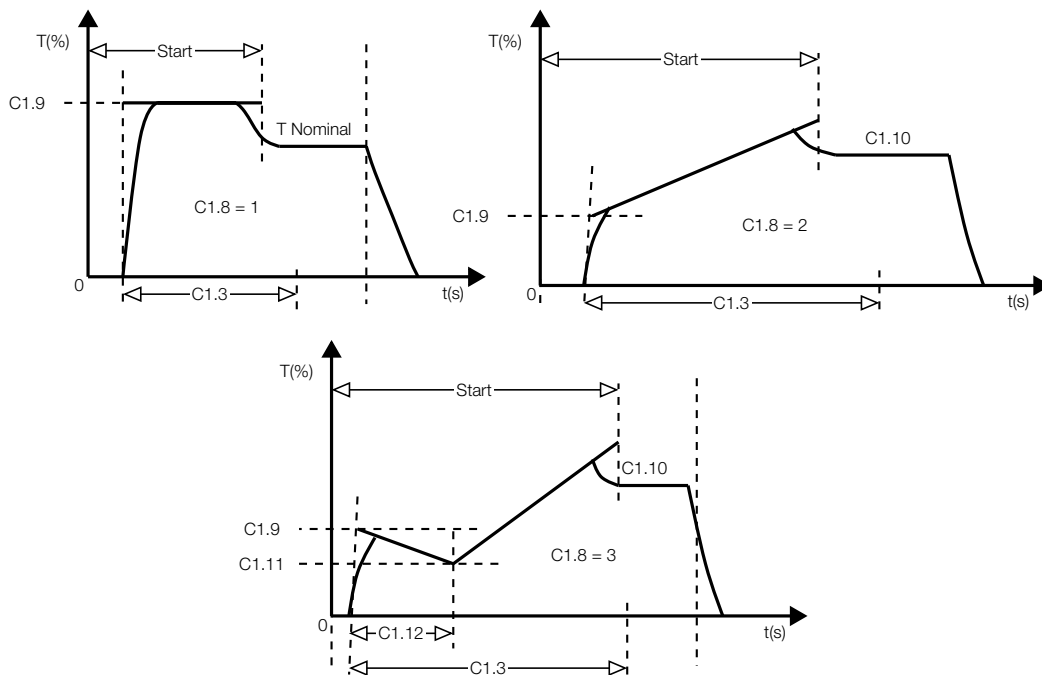

Figure 11.8: Available starting torque profiles.

Indication	Description
1 = Constant	1 setting point.
2 = Linear	2 setting points.
3 = Square	3 setting points.



NOTE!

Choose the torque control type easier to program and to adjust, and according to your knowledge of the used load characteristics.

C1 Starting and Stopping
C1.9 Initial Start Torque

Range:	10 ... 300 %	Default: 30
Properties:	Stopped	

Description:

It allows programming an initial or constant starting torque, according to the starting torque characteristic selected in C1.8.

C1.8 Programming	C1.9 Description
1 (Constant)	C1.9 limits the maximum torque throughout the starting
2 (Linear)	C1.9 limits the initial starting torque
3 (Quadratic)	C1.9 limits the initial starting torque

Table 11.2: C1.9 function according to C1.8

C1 Starting and Stopping
C1.10 End Start Torque

Range:	10 ... 300 %	Default: 110
Properties:	Stopped	

Description:

It makes possible the programming of an end starting torque limit if either linear or quadratic torque is selected in C1.8.

C1.8 Programming	C1.10 Description
1 (Constant)	C1.10 has no function
2 (Linear)	C1.10 limits the initial starting torque
3 (Quadratic)	C1.10 limits the initial starting torque

Table 11.3: C1.10 function according to C1.8

C1 Starting and Stopping
C1.11 Minimu Start Torque

Range:	10 ... 300 %	Default: 27
Properties:	Stopped	

Description:

It makes possible the programming of an intermediate starting torque limit if quadratic torque has been selected in C1.8.

C1.8 Programming	C1.11 Description
1 (Constant)	C1.11 has no function
2 (Linear)	C1.11 has no function
3 (Quadratic)	C1.11 limits the intermediate starting torque

Table 11.4: C1.11 function according to C1.8

C1 Starting and Stopping
C1.12 Min.Start Torq. Time

Range:	1 ... 99 %	Default: 20
Properties:	Stopped	

Description:

It makes possible the programming of the intermediate starting torque limit time, as a percentage of the maximum time defined in C1.3, if quadratic torque characteristic has been selected in C1.8.

C1.8 Programming	C1.12 Description
1 (Constant)	C1.12 has no function
2 (Linear)	C1.12 has no function
3 (Quadratic)	C1.12 set the time for the intermediate starting torque

Table 11.5: C1.12 function according to C1.8

C1 Starting and Stopping
C1.13 Stop Time

Range:	0 ... 999 s	Default: 0
Properties:	Stopped	

Description:

It is used with hydraulic pump applications. It makes it possible to perform a controlled deceleration, by enabling and adjusting the voltage decrease ramp time.

For more details on how to program and to apply it, refer to the Pump Control. It can be used with the control types: Voltage Ramp, Pump Control, Current Limit and Current Ramp.

NOTE!

This function is used to extend the normal deceleration time of the load, and not to force a time shorter than the required by the load itself.

C1 Starting and Stopping
C1.14 Step Down Volt. Stop

Range:	60 ... 100 %	Default: 100
Properties:	Stopped	

Description:

It is used with hydraulic pump applications. It adjusts the percentage of the nominal voltage (% Un) that will be applied to the motor instantaneously when the SSW receives the command to decelerate by voltage ramp.

NOTE!

A deceleration ramp time, stopping time, must be programmed, so that this function operates.

C1 Starting and Stopping
C1.15 End Voltage Stop

Range:	30 ... 55 %	Default: 30
Properties:	Stopped	

Description:

It is used with hydraulic pump applications. It adjusts the percentage of the nominal voltage (% Un) that will be applied to the motor at the end of the deceleration ramp.

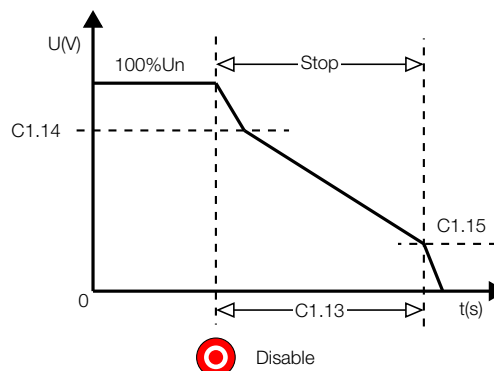

Figure 11.9: Deceleration ramp by voltage

C1 Starting and Stopping

C1.16 Stop Torque Characte.

Range:	1 ... 3	Default: 1
Properties:	Stopped	

Description:

It allows choosing which torque profile the SSW will follow during the motor stopping.

Three torque limit profiles are available, which make it possible to improve the speed performance during the stopping process.

Indication	Description
1 = Constant	1 setting point.
2 = Linear	2 setting points.
3 = Square	3 setting points.

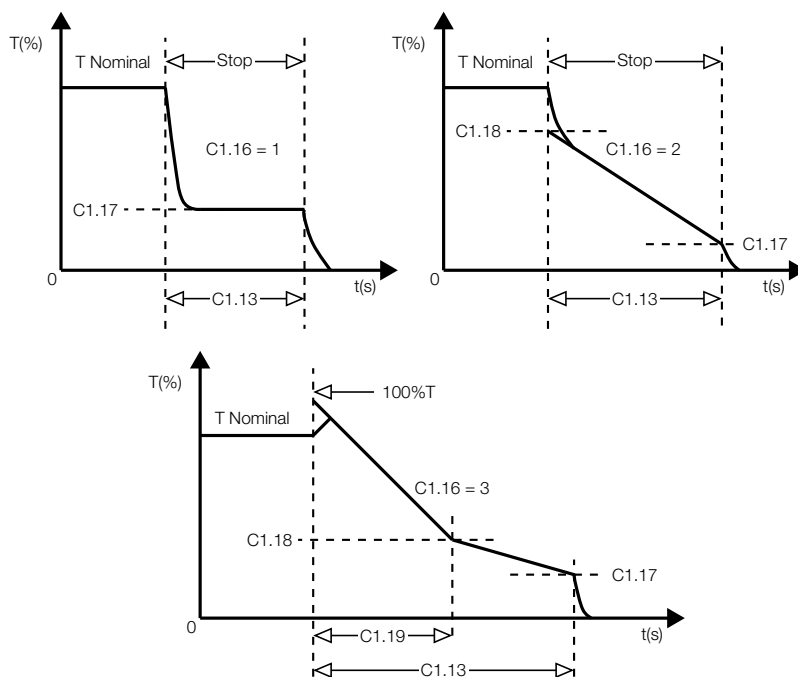

Figure 11.10: Available stopping torque profiles.



NOTE!

Choose the torque control type easier to program and to adjust, and according to your knowledge of the used load characteristics.

C1 Starting and Stopping

C1.17 End Stop Torque

Range:	10 ... 100 %	Default: 20
Properties:	Stopped	

Description:

It allows programming a final or constant stopping torque, according to the torque characteristic selected in C1.16.

C1.16 Programming	C1.17 Description
1 (Constant)	C1.17 limits the maximum torque throughout the stopping.
2 (Linear)	C1.17 limits the final stopping torque.
3 (Quadratic)	C1.17 limits the final stopping torque.

Table 11.6: C1.17 function according to C1.16.

C1 Starting and Stopping
C1.18 Minimum Stop Torque

Range:	10 ... 100 %	Default: 50
Properties:	Stopped	

Description:

It allows programming an initial or intermediate stopping torque, if linear or quadratic torque has been selected in C1.16.

C1.16 Programming	C1.18 Description
1 (Constant)	C1.18 has no function.
2 (Linear)	C1.18 limits the torque soon after a stop command.
3 (Quadratic)	C1.18 limits the intermediate stopping torque.

Table 11.7: C1.18 function according to C1.16.

C1 Starting and Stopping
C1.19 Min. Stop Torque Time

Range:	1 ... 99 %	Default: 50
Properties:	Stopped	

Description:

It makes possible the programming of the intermediate stopping torque limit time, as a percentage of the maximum time defined in C1.3, if quadratic torque characteristic has been selected in C1.16.

C1.16 Programming	C1.19 Description
1 (Constant)	C1.19 has no function.
2 (Linear)	C1.19 has no function (time = 0).
3 (Quadratic)	C1.19 sets the time for the intermediate stopping torque.

Table 11.8: C1.19 function according to C1.16.

C2 NOMINAL MOTOR DATA

Information and characteristics of motor nameplate.

NOTE!

The motor data programmed in C.2 (from C2.1 to C2.6) must be exactly those presented on the motor nameplate.

C2 Nominal Motor Data
C2.1 Voltage

Range:	1 ... 999 V	Default: 380
Properties:	Stopped	

Description:

Adjust this parameter according to the motor nameplate data.

All the voltage protections are based on the content of this parameter. As well as the synchronism of the SSW with the PLL supply line (S1.6).

C2 Nominal Motor Data
C2.2 Current

Range:	0.1 ... 2424.0 A	Default: 20.0
Properties:	Stopped	

Description:

Adjust this parameter according to the motor nameplate data.

The current protections and current limit are based on the content of this parameter.

NOTE!

1. In order that the protections based on the current reading and indication operate properly, the motor rated current must not be less than 30% of the SSW rated current.
2. We do not recommend the use of motors that operate in steady state with less than 50% of their rated load.
3. Program the motor nominal current according to the line voltage.

C2 Nominal Motor Data
C2.3 Speed

Range:	1 ... 3600 rpm	Default: 1780
Properties:	Stopped	

Description:

Adjust this parameter according to the motor nameplate data.

The programmed speed must be exactly what is written on the motor nameplate, already considering the slip.

C2 Nominal Motor Data
C2.4 Power

Range:	0.1 ... 1950.0 kW	Default: 7.5
Properties:	Stopped	

Description:

Adjust this parameter according to the motor nameplate data.

If the power is expressed in CV or HP, just multiply the value by 0,74 to convert in kW.

C2 Nominal Motor Data
C2.5 P.F. Power Factor

Range:	0.01 ... 1.0	Default: 0.89
Properties:	Stopped	

Description:

Adjust this parameter according to the motor nameplate data.

C2 Nominal Motor Data
C2.6 S.F. Service Factor

Range:	0.01 ... 1.5	Default: 1.0
Properties:	Stopped	

Description:

Adjust this parameter according to the motor nameplate data.

C3 LOC/REM SELECTION

SSW command source settings.

C3 LOC/REM Selection
C3.1 Mode

Range:	0 ... 12	Default: 2
Properties:		

Description:

It defines the origin of the command that will select between the LOCAL mode and the REMOTE mode.

Indication	Description
0 = Always LOC	Can not be changed. Fixed in LOCAL.
1 = Always REM	Can not be changed. Fixed in REMOTE.
2 = HMI LR Key LOC	Selection via IHM Key. Initialized in LOCAL.
3 = HMI LR Key REM	Selection via IHM Key. Initialized in REMOTE.
4 = DIx	Selection via digital input. It depends on the state of digital input (C4.1).
5 = USB LOC	Selection via USB command. Initialized in LOCAL.
6 = USB REM	Selection via USB command. Initialized in REMOTE.
7 = SoftPLC LOC	Selection via SoftPLC command. Initialized in LOCAL.
8 = SoftPLC REM	Selection via SoftPLC command. Initialized in REMOTE.
9 = Slot 1 LOC	Selection via SLOT1 accessory command. Initialized in LOCAL.
10 = Slot 1 REM	Selection via SLOT1 accessory command. Initialized in REMOTE.
11 = Slot 2 LOC	Selection via SLOT2 accessory command. Initialized in LOCAL.
12 = Slot 2 REM	Selection via SLOT2 accessory command. Initialized in REMOTE.

With the factory settings, the LOC/REM key will select between LOCAL and REMOTE mode. The SSW will initiate in LOCAL mode (Default LOCAL) upon energization.

C3 LOC/REM Selection
C3.2 LOC Command

Range: 0 ... 5

Default: 0

Properties:

Description:

It defines the origin of the SSW start and stop commands in LOCAL mode.

Indication	Description
0 = HMI Keys	Commands by the HMI keys.
1 = DIx	Commands by digital inputs.
2 = USB	Commands by control word of the USB.
3 = SoftPLC	Commands by control word of the SoftPLC.
4 = Slot 1	Commands by control word of the accessory of SLOT1.
5 = Slot 2	Commands by control word of the accessory of SLOT2.

C3 LOC/REM Selection
C3.3 REM Command

Range: 0 ... 5

Default: 1

Properties:

Description:

It defines the origin of the SSW start and stop commands in REMOTE mode.

Indication	Description
0 = HMI Keys	Commands by the HMI keys.
1 = DIx	Commands by digital inputs.
2 = USB	Commands by control word of the USB.
3 = SoftPLC	Commands by control word of the SoftPLC.
4 = Slot 1	Commands by control word of the accessory of SLOT1.
5 = Slot 2	Commands by control word of the accessory of SLOT2.

C3 LOC/REM Selection
C3.4 Commands Copy

Range: 0 ... 1

Default: 0

Properties:

Description:

When changing the commands source LOCAL to REMOTE, or REMOTE to LOCAL, allows you to copy the commands of the active source to the new source.

Indication	Description
0 = No	Not execute.
1 = Yes	Execute.

The copied commands are: START/STOP, GENERAL ENABLE and FORWARD/REVERSE.

DANGER!

When using option 1=Yes, you must be careful, because in the change of LOC/REM, or REM/LOC, to a source that is not being used, you can not have more STOP motor command.

C4 I/O

Parameters to configure all inputs and outputs of the SSW control board.

C4.1 Digital Inputs

Parameters to configure the functions of the digital inputs, according to the listed options.

Some notes regarding the Digital Input functions are presented next:

- **Start/Stop** = Closed (1) / Open (0) digital input, respectively. In order to assure the correct operation of this function, it is necessary to program LOC Command with DIx (C3.2=1) and/or REM Command with DIx (C3.3=1). Do not program more than one input for the Start/Stop function.
- **Start (3 Wires)** = When one digital input is programmed for Start (3-Wires), it is mandatory to program another one digital input for Stop (3-Wires). Use pushbuttons normally open.
- **Stop (3 Wires)** = When one digital input is programmed for Stop (3-Wires), it is mandatory to program another one digital input for Start (3-Wires). Use pushbuttons normally close.
- **General Enable / General Disable** = Closed (1) / Opened (0) digital input, respectively. This function allows starting the motor when General Enable is active, as well as stopping it without deceleration ramp when a General Disable command is given. There is no need to program a General Enable to be able to start the motor. If programmed, however, the input must be closed so that starting the motor becomes possible even if the commands are not via digital inputs.
- **Local / Remote** = Opened (0) / Closed (1) digital input, respectively. Do not program more than one input for this function.
- **Jog** = It makes it possible to enable slow speed via a digital input. JOG is activated when the input is closed. Use only pushbuttons for this function. If more than one digital input is programmed for this function, any one that is closed enables JOG.
- **Forward / Reverse** = Digital input opened (0) K1 closed and K2 opened, digital input closed (1) K1 opened and K2 closed. It makes possible the control of the rotation direction change. Do not program more than one input for this function. For more details, refer to the SSW900 User's Manual - Recommended Set-ups.

- **No External Fault** = There is no external fault “External Fault” (F091) if the digital input is closed (1).
- **No External Alarm** = This function will indicate “External Alarm” (A090) on the HMI display when the digital input programmed for this function is open (0). If closed (1), the alarm message will disappear automatically from the HMI display. The motor keeps operating normally, regardless of the state of this input.
- **Braking Off** = Digital input opened (0) without braking, digital input closed (1) with braking. In case of safety issues, it makes it possible to use a stopping sensor to disable the braking immediately. If more than one input is programmed for this function, if only one is opened, it will immediately disable the braking. In order to allow the braking activation the digital input must be closed.
- **Reset** = It resets the faults when the digital input is closed (1). A pushbutton must be used, because if the input remains closed no further reset will occur.
- **Load User 1/2** = This function allows the selection of the user memory 1 or 2, in a similar process than C10.1.1=1 or 2, with the difference that the user memory is loaded from a transition of the Dlx programmed for this function.

When the state of the Dlx changes from low level (0) to high level (1), the user memory 1 is loaded, provided that the contents of the SSW actual parameters had been previously transferred to the parameter memory 1 (C10.1.1=4).

When the state of the Dlx changes from high level (1) to low level (0), the user memory 2 is loaded, provided that the contents of the SSW actual parameters had been previously transferred to the parameter memory 2 (C10.1.1=5).

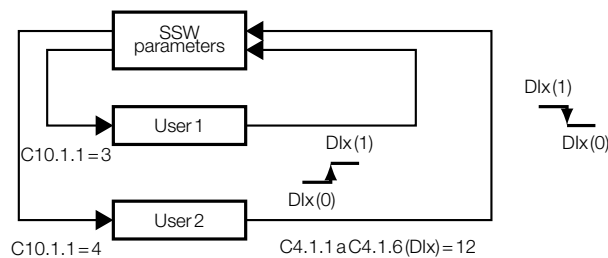

Figure 11.11: Details on the Load User 1/2 function operation.



NOTE!

It will not be possible to load a user memory with enabled motor.

- **Emergency Start = “Fire Mode”.** It makes possible start and stop the motor during any error action, not respecting the protections of SSW or the motor and, also, not respecting the source of active commands LOC/REM. This option is used for the hydraulic pumps of protection against fire.



NOTE!

The Emergency Start only must be used in emergency case, otherwise the SSW or the motor may be damaged.

- **Motor Thermistor** = The DI6 digital input is associated to the input of the motor thermistor (PTC). Acts if it is greater than 3900Ω. Releases is between 100Ω and 1600Ω. Less than 100Ω is indicated short circuit.

If you want to use DI6 as a normal digital input, you must, set the parameter of the DI6 (C4.1.6) with the desired function and short-circuit or open directly the pins 4 (PTCB) and 5 (PTCA). Digital input open (0), digital input closed (1).

C4.1 Digital Inputs
C4.1.1 DI1

Range:	0 ... 16	Default: 2
Properties:	Stopped	

Description:

Digital input 1 function. Pins 6 and 13 (24V) or 11 (0V).

Indication	Description
0 = Not Used	Only indicated in the digital input status.
1 = Start / Stop	Closed (Start) / Opened (Stop).
2 = Start (3 Wires)	When it closes.
3 = Stop (3 Wires)	When it opens.
4 = General Enable	Closed (General Enable) / Opened (General Disable).
5 = LOC / REM	Opened (LOCAL) / Closed (REMOTE).
6 = JOG	Closed (with JOG).
7 = FWD / REV	Opened (K1 closed and K2 opened) / Closed (K1 opened and K2 closed).
8 = No External Fault	Closed (Without External Fault) / Opened (With External Fault).
9 = No External Alarm	Closed (Without External Alarm) / Opened (With External Alarm).
10 = Brake	Opened (Without Braking) / Closed (With Braking).
11 = Reset	When it closes (If a fault is active, the fault is Reset).
12 = Load User 1/2	When it closes (Load User 1) / When it opens (Load User 2).
13 ... 16 = Reserved	Do not use.

C4.1 Digital Inputs
C4.1.2 DI2

Range:	0 ... 16	Default: 3
Properties:	Stopped	

Description:

Digital input 2 function. Pins 7 and 13 (24V) or 11 (0V).

Indication	Description
0 = Not Used	Only indicated in the digital input status.
1 = Start / Stop	Closed (Start) / Opened (Stop).
2 = Start (3 Wires)	When it closes.
3 = Stop (3 Wires)	When it opens.
4 = General Enable	Closed (General Enable) / Opened (General Disable).
5 = LOC / REM	Opened (LOCAL) / Closed (REMOTE).
6 = JOG	Closed (with JOG).
7 = FWD / REV	Opened (K1 closed and K2 opened) / Closed (K1 opened and K2 closed).
8 = No External Fault	Closed (Without External Fault) / Opened (With External Fault).
9 = No External Alarm	Closed (Without External Alarm) / Opened (With External Alarm).
10 = Brake	Opened (Without Braking) / Closed (With Braking).
11 = Reset	When it closes (If a fault is active, the fault is Reset).
12 = Load User 1/2	When it closes (Load User 1) / When it opens (Load User 2).
13 ... 16 = Reserved	Do not use.

C4.1 Digital Inputs
C4.1.3 DI3

Range:	0 ... 16	Default: 0
Properties:	Stopped	

Description:

Digital input 3 function. Pins 8 and 13 (24V) or 11 (0V).

Indication	Description
0 = Not Used	Do not use.
1 = Start / Stop	Closed (Start) / Opened (Stop).
2 = Start (3 Wires)	When it closes.
3 = Stop (3 Wires)	When it opens.
4 = General Enable	Closed (General Enable) / Opened (General Disable).
5 = LOC / REM	Opened (LOCAL) / Closed (REMOTE).
6 = JOG	Closed (with JOG).
7 = FWD / REV	Opened (K1 closed and K2 opened) / Closed (K1 opened and K2 closed).
8 = No External Fault	Closed (Without External Fault) / Opened (With External Fault).
9 = No External Alarm	Closed (Without External Alarm) / Opened (With External Alarm).
10 = Brake	Opened (Without Braking) / Closed (With Braking).
11 = Reset	When it closes (If a fault is active, the fault is Reset).
12 = Load User 1/2	When it closes (Load User 1) / When it opens (Load User 2).
13 = Reserved	Do not use.
14 = Emergency Start	Closed (Start) / Opened (Stop).
15 ... 16 = Reserved	Do not use.

C4.1 Digital Inputs
C4.1.4 DI4

Range:	0 ... 16	Default: 0
Properties:	Stopped	

Description:

Digital input 4 function. Pins 9 and 13 (24V) or 11 (0V).

Indication	Description
0 = Not Used	Only indicated in the digital input status.
1 = Start / Stop	Closed (Start) / Opened (Stop).
2 = Start (3 Wires)	When it closes.
3 = Stop (3 Wires)	When it opens.
4 = General Enable	Closed (General Enable) / Opened (General Disable).
5 = LOC / REM	Opened (LOCAL) / Closed (REMOTE).
6 = JOG	Closed (with JOG).
7 = FWD / REV	Opened (K1 closed and K2 opened) / Closed (K1 opened and K2 closed).
8 = No External Fault	Closed (Without External Fault) / Opened (With External Fault).
9 = No External Alarm	Closed (Without External Alarm) / Opened (With External Alarm).
10 = Brake	Opened (Without Braking) / Closed (With Braking).
11 = Reset	When it closes (If a fault is active, the fault is Reset).
12 = Load User 1/2	When it closes (Load User 1) / When it opens (Load User 2).
13 ... 16 = Reserved	Do not use.

C4.1 Digital Inputs
C4.1.5 DI5

Range:	0 ... 16	Default: 0
Properties:	Stopped	

Description:

Digital input 5 function. Pins 10 and 13 (24V) or 11 (0V).

Indication	Description
0 = Not Used	Only indicated in the digital input status.
1 = Start / Stop	Closed (Start) / Opened (Stop).
2 = Start (3 Wires)	When it closes.
3 = Stop (3 Wires)	When it opens.
4 = General Enable	Closed (General Enable) / Opened (General Disable).
5 = LOC / REM	Opened (LOCAL) / Closed (REMOTE).
6 = JOG	Closed (with JOG).
7 = FWD / REV	Opened (K1 closed and K2 opened) / Closed (K1 opened and K2 closed).
8 = No External Fault	Closed (Without External Fault) / Opened (With External Fault).
9 = No External Alarm	Closed (Without External Alarm) / Opened (With External Alarm).
10 = Brake	Opened (Without Braking) / Closed (With Braking).
11 = Reset	When it closes (If a fault is active, the fault is Reset).
12 = Load User 1/2	When it closes (Load User 1) / When it opens (Load User 2).
13 ... 16 = Reserved	Do not use.

C4.1 Digital Inputs

C4.1.6 DI6

Range:	0 ... 16	Default: 0
Properties:	Stopped	

Description:

Digital input 6 function. Pins 4 and 5.

Indication	Description
0 = Not Used	Only indicated in the digital input status.
1 = Start / Stop	Closed (Start) / Opened (Stop).
2 = Start (3 Wires)	When it closes.
3 = Stop (3 Wires)	When it opens.
4 = General Enable	Closed (General Enable) / Opened (General Disable).
5 = LOC / REM	Opened (LOCAL) / Closed (REMOTE).
6 = JOG	Closed (with JOG).
7 = FWD / REV	Opened (K1 closed and K2 opened) / Closed (K1 opened and K2 closed).
8 = No External Fault	Closed (Without External Fault) / Opened (With External Fault).
9 = No External Alarm	Closed (Without External Alarm) / Opened (With External Alarm).
10 = Brake	Opened (Without Braking) / Closed (With Braking).
11 = Reset	When it closes (If a fault is active, the fault is Reset).
12 = Load User 1/2	When it closes (Load User 1) / When it opens (Load User 2).
13 ... 14 = Reserved	Do not use.
15 = Mot. Thermistor A032	It acts as Alarm.
16 = Mot. Thermistor F032	It acts as Fault.

C4.2 Digital Outputs

Parameters to configure the functions of the digital outputs, according to the listed options. When the condition declared by the function is true, the digital output will be activated.

Next, some additional notes on the relay digital output functions are presented:

- **Not Used:** it means that the digital outputs will remain always in a resting state, i.e., DOx = relay with the coil not energized.
- **Running:** the output will be enabled instantly with the SSW Start command, and will only be disabled when the SSW receives the command Stop, or when the end of the deceleration ramp is reached, if programmed.

- **Full Voltage:** the output will be activated when the SSW reaches 100 %Un, and it will be deactivated when the SSW receives a disabling command.
- **Bypass:** operation with features like "Full Voltage", but the output is activated when the bypass contactor is enabled.
- **FWD/REV-K1:** this operation is similar to the "Running", but it must be enabled with forward motor direction of rotation.
- **FWD/REV-K2:** this operation is similar to the "Running", but it must be enabled with reverse motor direction of rotation.
- **DC Braking:** the output is activated during the DC braking.
- **Without Fault:** the output will stay activated as long as the SSW remains with no fault, i.e., if the SSW is not disabled by any type of fault.
- **With Fault:** the output will stay activated as long as the SSW remains a fault, i.e., if the SSW is disabled by some type of fault.
- **Without Alarm:** it means that the SSW is not in the alarm condition.
- **With Alarm:** it means that the SSW is in the alarm condition.
- **No Fault and No Alarm:** it means that the SSW is not disabled by any type of fault and it is not in the alarm condition.
- **SoftPLC:** it means that the digital output state will be controlled by the programming done in the memory area reserved to the SoftPLC function. For more details, refer to the Help text of WPS (WEG Programming Suite) Software.
- **Communication:** it means that the digital output state will be controlled by the parameter S5.3.1 Net Id:0695, witch is written via network communication. For more details regarding this parameter, refer to SSW900 Modbus-RTU User's Manual.
- **I motor % > DO Comparison Value:** the output will be activated when the current value in percent of the nominal motor current is greater than the value programmed in the parameter DO Comparison Value (C4.2.4) during full voltage, after the motor starting and without deceleration. This function has a hysteresis of 10 % of the programmed value to deactivate the digital output.
- **Breaker Shunt Trip:** When one of the following faults occur: F015, F018, F019, F020, F077, F084 or F099, the output is activated. The tripping of any of these protections may indicate that the SSW has a short circuit in the power circuit, thyristors or by-pass. They can be used to open the power isolation circuit breaker (Q1). For more information, see the SSW900 User's Manual - Recommended Set-ups.

C4.2 Digital Outputs

C4.2.1 DO1

Range:	0 ... 14	Default: 1
Properties:	Stopped	

Description:

Digital output 1 function. Pins 14 and 15 (normally open).

Indication	Description
0 = Not Used	Always open.
1 = Running	Closed in Operation. Other status of the open SSW.
2 = Full Voltage	Closed at Full Voltage. Other status of the open SSW.
3 = Bypass	Closed in Bypass. Other status of the open SSW.
4 = FWD / REV K1	Closed with forward Direction of Rotation. Open with reverse Direction of Rotation..
5 = DC Braking	Closed in DC Braking. Other status of the open SSW.
6 = Without Fault	Closed without fault. Opened with fault.
7 = With Fault	Closed with fault. Opened without fault.
8 = Without Alarm	Closed without alarm. Opened with alarm.
9 = With Alarm	Closed with alarm. Opened without alarm.
10 = No Fault / Alarm	Closed without fault and alarm. Opened with fault or alarm.
11 = SoftPLC	Controlled via SoftPLC. 0 = open, 1 = close.
12 = Communication	Controlled via serial communication. 0 = open, 1 = close.
13 = I motor % > Value	Closed if I motor % > Value. Opened if I motor % < or = Value.
14 = Breaker Shunt Trip	Closed with fault F015, F018, F019, F020, F077, F084 or F099. Opened without fault.

C4.2 Digital Outputs

C4.2.2 DO2

Range:	0 ... 14	Default: 3
Properties:	Stopped	

Description:

Digital output 2 function. Pins 16 and 17 (normally open).

Indication	Description
0 = Not Used	Always open.
1 = Running	Closed in Operation. Other status of the open SSW.
2 = Full Voltage	Closed at Full Voltage. Other status of the open SSW.
3 = Bypass	Closed in Bypass. Other status of the open SSW.
4 = FWD / REV K2	Closed with reverse Direction of Rotation. Open with forward Direction of Rotation.
5 = DC Braking	Closed in DC Braking. Other status of the open SSW.
6 = Without Fault	Closed without fault. Opened with fault.
7 = With Fault	Closed with fault. Opened without fault.
8 = Without Alarm	Closed without alarm. Opened with alarm.
9 = With Alarm	Closed with alarm. Opened without alarm.
10 = No Fault / Alarm	Closed without fault and alarm. Opened with fault or alarm.
11 = SoftPLC	Controlled via SoftPLC. 0 = open, 1 = close.
12 = Communication	Controlled via serial communication. 0 = open, 1 = close.
13 = I motor % > Value	Closed if I motor % > Value. Opened if I motor % < or = Value.
14 = Breaker Shunt Trip	Closed with fault F015, F018, F019, F020, F077, F084 or F099. Opened without fault.

C4.2 Digital Outputs

C4.2.3 DO3

Range:	0 ... 14	Default: 7
Properties:	Stopped	

Description:

Digital output 3 function. Pins 18 and 19 (normally open), 20 and 19 (normally closed).

Indication	Description
0 = Not Used	18-19 Always open. 20-19 Inverted.
1 = Running	18-19 Closed in Operation. Other status of the open SSW. 20-19 Inverted.
2 = Full Voltage	18-19 Closed at Full Voltage. Other status of the open SSW. 20-19 Inverted.
3 = Bypass	18-19 Closed in Bypass. Other status of the open SSW. 20-19 Inverted.
4 = Not Used	Do not use.
5 = DC Braking	18-19 Closed in DC Braking. Other status of the open SSW. 20-19 Inverted.
6 = Without Fault	18-19 Closed without fault. Open with fault. 20-19 Inverted.
7 = With Fault	18-19 Closed without fault. Open with fault. 20-19 Inverted.
8 = Without Alarm	18-19 Closed without fault. Opened with fault. 20-19 Inverted.
9 = With Alarm	18-19 Closed with alarm. Opened without alarm. 20-19 Inverted.
10 = No Fault / Alarm	18-19 Closed without fault and alarm. Opened with fault or alarm. 20-19 Inverted.
11 = SoftPLC	18-19 Controlled via SoftPLC. 0 = open, 1 = close. 20-19 Inverted.
12 = Communication	18-19 Controlled via serial communication. 0 = open, 1 = close. 20-19 Inverted.
13 = I motor % > Value	18-19 Closed if I motor % > Value. Opened if I motor % < or = Value. 20-19 Inverted.
14 = Breaker Shunt Trip	18-19 Closed with fault F015, F018, F019, F020, F077, F084 or F099. Opened without fault. 20-19 Inverted.

C4.2 Digital Outputs

C4.2.4 DO Comparison Value

Range: 10.0 ... 500.0 %

Default: 100.0

Properties: Stopped

Description:

Comparison value for digital output activation. I motor % > Value.

C4.3 Analog Output

Parameters to configure the functions of the analog outputs.

C4.3 Analog Output

C4.3.1 Function

Range: 0 ... 11

Default: 0

Properties:

Description:

It defines what will be indicated in the analog output.

Indication	Description
0 = Not Used	Nothing.
1 = SSW Current %	Present motor current in percentage of the SSW rated current.
2 = Line Voltage %	Present power line voltage in percentage of the SSW maximum rated one.
3 = Output Voltage %	Present output voltage in percentage of the SSW maximum rated one.
4 = Power Factor	Present motor power factor.
5 = Thermal Class Prot.	Present status of the motor thermal class protection in percentage of the maximum one.
6 = Output Power W	Present motor power in kW.
7 = Output Power VA	Present motor power in kVA.
8 = Motor Torque %	Present motor torque in percentage of the rated one.
9 = Value to AO	Content written via communications.
10 = SCRs Temperature	Present temperature of the SCRs heatsink of the SSW.
11 = SoftPLC	Content written via SoftPLC.

C4.3 Analog Output

C4.3.2 Gain

Range: 0.0 ... 9.999

Default: 1.0

Properties:

Description:

It sets the gain of the analog output.

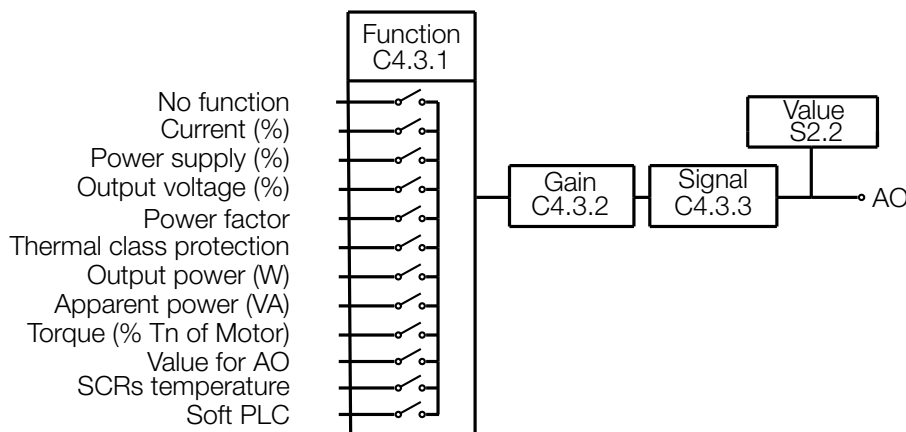

Figure 11.12: Analog output block diagram.

SCALE OF THE ANALOG OUTPUT INDICATIONS	
Variable	Full Scale (*)
SSW Current. %	5 x C9.1.1 (²)
Line Voltage.	1,5 x S3.3.2 (³)
Output Voltage.	
Power Factor.	1.00 = 100.0%
Motor Thermal Class Protection Status.	Maximum = 100.0%
Output Power. (W)	1,5 x √3 x C9.1.1 x S3.3.2 (²)(³)
Output Apparent Power. (VA)	
Motor Torque. %	Maximum = 250.0%
AO Value.	1023 (10 bits)
SCRs Temperature.	200 °C
SoftPLC.	1023 (10 bits)

Table 11.9: Full Scale.

(1) When the signal is inverse (10 to 0 V, 20 to 0 mA or 20 to 4 mA) the values in the table become the beginning of the scale.

(²) C9.1.1 = SSW Nominal Current (Configurations\SSW900\Nominal Data\Current).

(³) S3.3.2 = Maximum value of SSW voltage (Status\SSW900\SSW Model\Voltage).

C4.3 Analog Output
C4.3.3 Signal

Range:	0 ... 5	Default: 0
Properties:		

Description:

These parameters configure whether the analog output signal will be in current or voltage, and with direct or inverse reference.

Indication	Description
0 = 0 to 20mA	Beginning of scale 0mA, end of scale 20mA.
1 = 4 to 20mA	Beginning of scale 4mA, end of scale 20mA. From 0 to <4mA broken cable.
2 = 20mA to 0	Beginning of scale 20mA, end of scale 0mA.
3 = 20 to 4mA	Beginning of scale 20mA, end of scale 4mA. From <4mA to 0 broken cable.
4 = 0 to 10V	Beginning of scale 0V, end of scale 10V.
5 = 10V to 0	Beginning of scale 10V, end of scale 0V.

C5 PROTECTIONS

Allows configuring the operation mode, levels and tripping time of the SSW and motor protection.

C5.1 Voltage Protections

Allows configuring the motor voltage protections.

C5.1.1 Motor Undervoltage

Wrong voltage protection, undervoltage or missing phase on the supply line.

C5.1.1 Motor Undervoltage
C5.1.1.1 Mode

Range:	0 ... 2	Default: 1
Properties:	Stopped	

Description:

It programs the tripping mode of the undervoltage protection.

Indication	Description
0 = Inactive	No tripping.
1 = Fault F002	Trips as fault. Disables the motor.
2 = Alarm A002	Trips as alarm. It is just indicated.

C5.1.1 Motor Undervoltage
C5.1.1.2 Level

Range:	0 ... 30 %Vn	Default: 20
Properties:	Stopped	

Description:

Level for the undervoltage protection tripping. It means how many % below the rated one it must trip. Ex.: 10% = rated motor voltage - 10%.

C5.1.1 Motor Undervoltage
C5.1.1.3 Time

Range:	0.1 ... 10.0 s	Default: 0.5
Properties:	Stopped	

Description:

Tripping time of the undervoltage protection.

C5.1.2 Motor Overvoltage

Wrong voltage protection, overvoltages.

C5.1.2 Motor Overvoltage
C5.1.2.1 Mode

Range:	0 ... 2	Default: 1
Properties:	Stopped	

Description:

It programs the tripping mode of the overvoltage protection.

Indication	Description
0 = Inactive	No tripping.
1 = Fault F016	Trips as fault. Disables the motor.
2 = Alarm A016	Trips as alarm. It is just indicated.

C5.1.2 Motor Overvoltage
C5.1.2.2 Level

Range:	0 ... 20 %Vn	Default: 15
Properties:	Stopped	

Description:

Level for the overvoltage protection tripping. It means how many % above the rate one it must trip. Ex.: 10% = motor rated voltage + 10%.

C5.1.2 Motor Overvoltage
C5.1.2.3 Time

Range:	0.1 ... 10.0 s	Default: 0.5
Properties:	Stopped	

Description:

Tripping time of the overvoltage protection.

The over- and undervoltage values are adjusted as a percentage of the motor rated voltage.

$$\text{undervoltage (\%)} = (100\% - S1.2.5)$$

$$\text{overvoltage (\%)} = (S1.2.5 - 100\%)$$

S1.2.5 is the present supply voltage in percentage of the rated motor voltage (Motor %Vn).

C5.1.1.1 e C5.1.2.1 program the over- and undervoltage protections operation. If it is programmed for fault, the motor is deactivated and the fault message is presented on the HMI. If it is programmed for alarm, the motor keeps running and the alarm message is presented on the HMI display.

C5.1.1.2 adjusts the undervoltage level of the power supply that the motor can withstand during the period adjusted in C5.1.1.3, after which the SSW executes the action programmed in C5.1.1.1.

C5.1.2.2 adjusts the overvoltage level of the power supply that the motor can withstand during the period adjusted in C5.1.2.3, after which the SSW executes the action programmed in C5.1.2.1.

NOTE! These functions are active all the way through the motor operation.

For programming examples refer to the section 13.8.

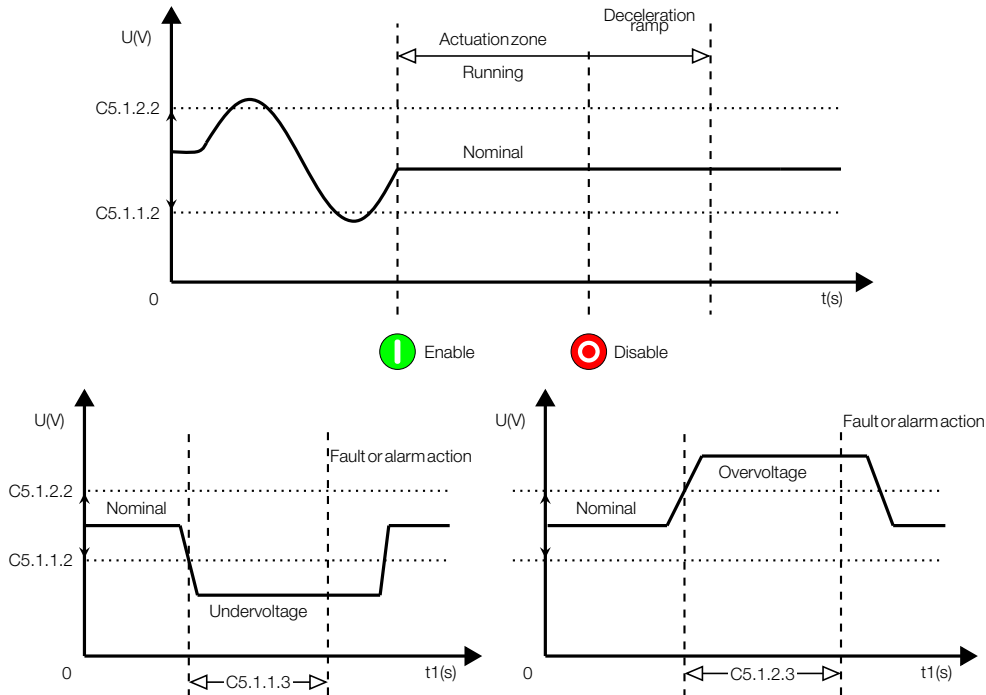

Figure 11.13: Over- and Undervoltage trip levels.

C5.1.3 Motor Voltage Imbalance

Phase loss protection or some power line phase missing.

C5.1.3 Motor Voltage Imbalance

C5.1.3.1 Mode

Range:	0 ... 2	Default: 1
Properties:	Stopped	

Description:
It programs the tripping mode of the voltage imbalance protection.

Indication	Description
0 = Inactive	No tripping.
1 = Fault F001	Trips as fault. Disables the motor.
2 = Alarm A001	Trips as alarm. It is just indicated.

C5.1.3 Motor Voltage Imbalance

C5.1.3.2 Level

Range:	0 ... 30 %Vn	Default: 15
Properties:	Stopped	

Description:

Level for the voltage imbalance protection tripping. It means how many % below the rated one it must trip.

C5.1.3 Motor Voltage Imbalance
C5.1.3.3 Time

Range:	0.1 ... 10.0 s	Default: 0.5
Properties:	Stopped	

Description:

Tripping time of the voltage imbalance protection.

The voltage imbalance values are adjusted as a percentage of the motor rated voltage C2.1.

$$V_{RS}(\%Vn) - V_{ST}(\%Vn) = \left(\frac{S1.2.1}{C2.1} - \frac{S1.2.2}{C2.1} \right) \times 100\%$$

$$V_{ST}(\%Vn) - V_{TR}(\%Vn) = \left(\frac{S1.2.2}{C2.1} - \frac{S1.2.3}{C2.1} \right) \times 100\%$$

$$V_{TR}(\%Vn) - V_{RS}(\%Vn) = \left(\frac{S1.2.3}{C2.1} - \frac{S1.2.1}{C2.1} \right) \times 100\%$$

S1.2.1, S1.2.2, S1.2.3 are the input main line voltage and C2.1 is the motor rated voltage.

C5.1.3.1 programs the voltage imbalance protection operation. If it is programmed for fault, the motor is deactivated and the fault message is presented on the HMI. If it is programmed for alarm, the motor keeps running and the alarm message is presented on the HMI display.

C5.1.3.2 adjusts the maximum voltage imbalance between the three lines of the power supply that the motor can withstand during the period adjusted in C5.1.3.3, after which the SSW executes the action programmed in C5.1.3.1.

Phase loss, during the starting as well as during full voltage, is detected through these settings.

NOTE!

This function is active all the way through the motor operation.

C5.2 Current Protections

It allows configuring the motor current protections.

C5.2.1 Motor Undercurrent

Protection to prevent the motor from running with currents below a certain value.

C5.2.1 Motor Undercurrent
C5.2.1.1 Mode

Range:	0 ... 2	Default: 0
Properties:	Stopped	

Description:

It programs the undercurrent protection tripping mode.

Indication	Description
0 = Inactive	No tripping.
1 = Fault F065	Trips as fault. Disables the motor.
2 = Alarm A065	Trips as alarm. It is just indicated.

C5.2.1 Motor Undercurrent
C5.2.1.2 Level

Range:	0 ... 99 %In	Default: 20
Properties:	Stopped	

Description:

Level for the undercurrent protection tripping. It means how many % below the rated one it must trip. Ex.: 10% = motor rated current - 10%.

C5.2.1 Motor Undercurrent
C5.2.1.3 Time

Range:	1 ... 99 s	Default: 1
Properties:	Stopped	

Description:

Undercurrent tripping time.

C5.2.2 Motor Overcurrent

Protection against overloads or locked rotor when the motor is running at full voltage.

C5.2.2 Motor Overcurrent
C5.2.2.1 Mode

Range:	0 ... 2	Default: 0
Properties:	Stopped	

Description:

It programs the overcurrent protection tripping mode.

Indication	Description
0 = Inactive	No tripping.
1 = Fault F066	Trips as fault. Disables the motor.
2 = Alarm A066	Trips as alarm. It is just indicated.

C5.2.2 Motor Overcurrent
C5.2.2.2 Level

Range:	0 ... 99 %In	Default: 20
Properties:	Stopped	

Description:

Level for the overcurrent protection tripping. It means how many % above the rated one it must trip. Ex.: 10% = motor rated current + 10%.

C5.2.2 Motor Overcurrent
C5.2.2.3 Time

Range:	1 ... 99 s	Default: 1
Properties:	Stopped	

Description:

Overcurrent protection tripping time.

The over- and undercurrent values are adjusted as a percentage of the motor rated current C2.2.

$$\text{undercurrent (\%)} = (100\% - S1.1.5)$$

$$\text{overcurrent (\%)} = (S1.1.5 - 100\%)$$

S1.1.5 is the present current value in percentage of the motor rated current (Motor %In).

C5.2.1.1 and C5.2.2.1 program the over- and undercurrent protections operation. If it is programmed for fault, the motor is deactivated and the fault message is presented on the HMI. If it is programmed for alarm, the motor keeps running and the alarm message is presented on the HMI display.

C5.2.1.2 adjusts the undercurrent level that the motor can withstand during the period adjusted in C5.2.1.3, after which the SSW executes the action programmed in C5.2.1.1. It is used with hydraulic pump applications, where the pump cannot operate without load.

C5.2.2.2 adjusts the overcurrent level that allows the motor operation during the period adjusted in C5.2.2.3, after which the SSW executes the action programmed in C5.2.2.1.

NOTE! These functions are active only with full voltage, after the motor starting.

For programming examples refer to the section 13.8.

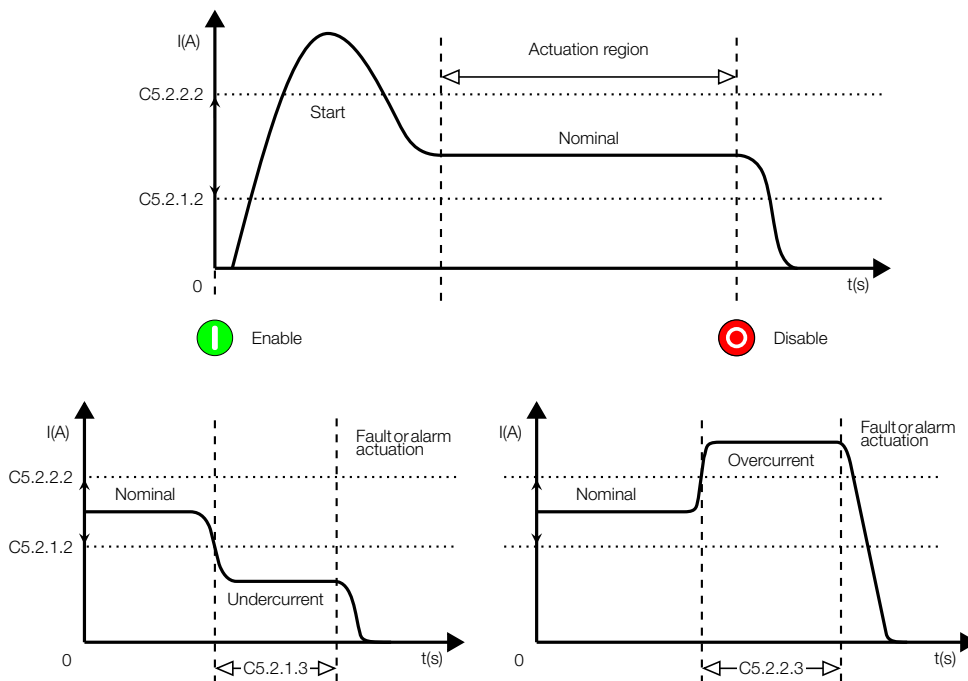

Figure 11.14: Over- and Undercurrent trip levels.

C5.2.3 Current Imbalance

Protection against phase loss on the motor or supply line.

C5.2.3 Current Imbalance

C5.2.3.1 Mode

Range: 0 ... 2 **Default:** 0

Properties: Stopped

Description:

It programs the tripping mode of the current imbalance between phases protection.

Indication	Description
0 = Inactive	No tripping.
1 = Fault F074	Trips as fault. Disables the motor.
2 = Alarm A074	Trips as alarm. It is just indicated.

C5.2.3 Current Imbalance
C5.2.3.2 Level

Range:	0 ... 30 %In	Default: 15
Properties:	Stopped	

Description:

Level for the current imbalance protection tripping. It means how many % above or below the rated one it must trip.

C5.2.3 Current Imbalance
C5.2.3.3 Time

Range:	1 ... 99 s	Default: 1
Properties:	Stopped	

Description:

Current imbalance tripping time.

The current imbalance values are adjusted as a percentage of the motor rated current C2.2.

$$I_R(\%Vn) - I_S(\%Vn) = \left(\frac{S1.1.1}{C2.2} - \frac{S1.1.2}{C2.2} \right) \times 100\%$$

$$I_S(\%Vn) - I_T(\%Vn) = \left(\frac{S1.1.2}{C2.2} - \frac{S1.1.3}{C2.2} \right) \times 100\%$$

$$I_T(\%Vn) - I_R(\%Vn) = \left(\frac{S1.1.3}{C2.2} - \frac{S1.1.1}{C2.2} \right) \times 100\%$$

S1.1.1, S1.1.2, S1.1.3 are the phase currents and C2.2 the motor rated current.

C5.2.3.1 programs the current imbalance protection operation. If it is programmed for fault, the motor is deactivated and the fault message is presented on the HMI. If it is programmed for alarm, the motor keeps running and the alarm message is presented on the HMI display.

C5.2.3.2 adjusts the maximum current imbalance between the three phases that the motor can withstand during the period adjusted in C5.2.3.3, after which the SSW executes the action programmed in C5.2.3.1.

Phase loss at full voltage operation is detected through these settings.

NOTE!

This function is active only with full voltage, after the motor starting.

C5.3 Torque Protections

It allows configuring the motor torque protections.

C5.3.1 Undertorque

Protection against underload or lack of load on the motor, programmed in percentage of the motor rated torque.

C5.3.1 Undertorque
C5.3.1.1 Mode

Range:	0 ... 2	Default: 0
Properties:	Stopped	

Description:

It programs the undertorque protection tripping mode.

Indication	Description
0 = Inactive	No tripping.
1 = Fault F078	Trips as fault. Disables the motor.
2 = Alarm A078	Trips as alarm. It is just indicated.

C5.3.1 Undertorque
C5.3.1.2 Level

Range:	0 ... 99 %T _n	Default: 30
Properties:	Stopped	

Description:

Levels for undertorque protection tripping. It means how many % below the rated one it must trip. Ex.: 10% = motor rated torque - 10%.

C5.3.1 Undertorque
C5.3.1.3 Time

Range:	1 ... 99 s	Default: 1
Properties:	Stopped	

Description:

Undertorque protection tripping time.

C5.3.2 Overtorque

Protection against overload or locked rotor of the motor running at full voltage, programmed in percentage of the motor rated torque.

C5.3.2 Overtorque
C5.3.2.1 Mode

Range:	0 ... 2	Default: 0
Properties:	Stopped	

Description:

It programs the overtorque protection tripping time.

Indication	Description
0 = Inactive	No tripping.
1 = Fault F079	Trips as fault. Disables the motor.
2 = Alarm A079	Trips as alarm. It is just indicated.

C5.3.2 Overtorque
C5.3.2.2 Level

Range:	0 ... 99 %T _n	Default: 30
Properties:	Stopped	

Description:

Level for overtorque protection tripping. It means how many % above the rated one it must trip. Ex.: 10% = motor rated torque + 10%.

C5.3.2 Overtorque
C5.3.2.3 Time

Range:	1 ... 99 s	Default: 1
Properties:	Stopped	

Description:

Overtorque protection tripping time.

The over- and undertorque values are adjusted as a percentage of the motor rated torque (100%).

$$\text{undertorque (\%)} = (100\% - S1.7.1)$$

$$\text{overtorque (\%)} = (S1.7.1 - 100\%)$$

S1.7.1 is the present motor torque in percentage of the motor rated torque (Motor %Tn).

C5.3.1.2 adjusts the undertorque level that the motor can withstand during the period adjusted in C5.3.1.3, after which the SSW executes the action programmed in C5.3.1.1. It can be used in applications with hydraulic pumps that cannot operate without load.

C5.3.2.2 adjusts the overtorque level that the motor can withstand during the period adjusted in C5.3.2.3, after which the SSW executes the action programmed in C5.3.2.1.

NOTE! These functions are active only with full voltage, after the motor starting.

For programming examples refer to the section 13.8.

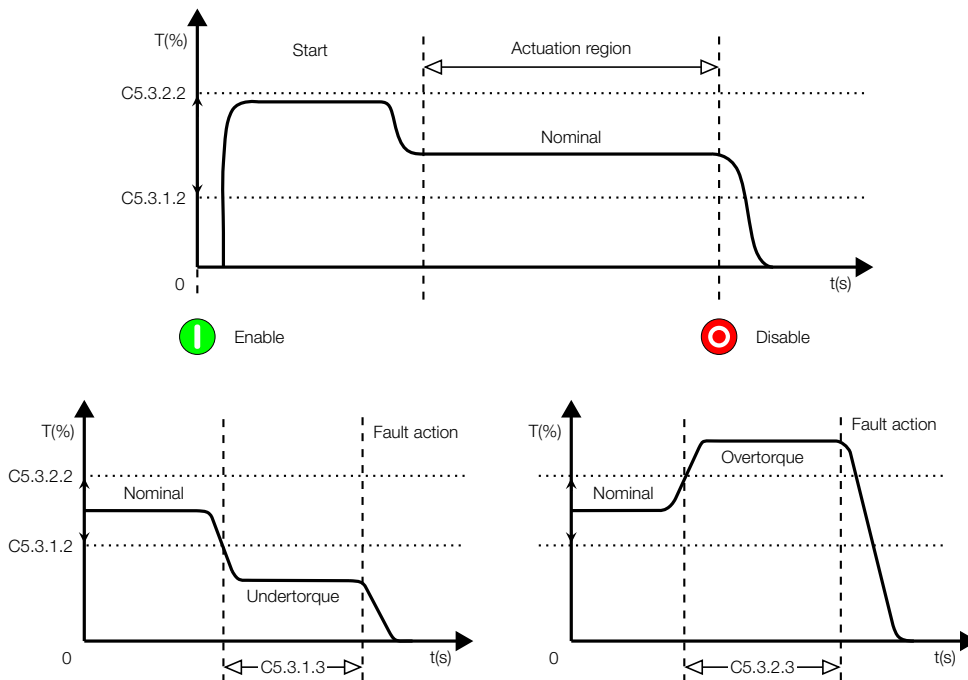

Figure 11.15: Over- and Undertorque trip levels.

C5.4 Power Protections

It allows configuring the motor power protections.

C5.4.1 Underpower

Protection against underload or lack of load on the motor, programmed in percentage of the motor rated power.

C5.4.1 Underpower
C5.4.1.1 Mode

Range:	0 ... 2	Default: 0
Properties:	Stopped	

Description:

It programs the underpower protection tripping mode.

Indication	Description
0 = Inactive	No tripping.
1 = Fault F080	Trips as fault. Disables the motor.
2 = Alarm A080	Trips as alarm. It is just indicated.

C5.4.1 Underpower
C5.4.1.2 Level

Range:	0 ... 99 %Pn	Default: 30
Properties:	Stopped	

Description:

Level for the underpower protection tripping. It means how many % below the rated one it must trip. Ex.: 10% = motor rated power - 10%.

C5.4.1 Underpower
C5.4.1.3 Time

Range:	1 ... 99 s	Default: 1
Properties:	Stopped	

Description:

Underpower protection tripping time.

C5.4.2 Overpower

Protections against overload or locked rotor of the motor running at full voltage, programmed in percentage of the motor rated power.

C5.4.2 Overpower
C5.4.2.1 Mode

Range:	0 ... 2	Default: 0
Properties:	Stopped	

Description:

It programs the overpower protection tripping mode.

Indication	Description
0 = Inactive	No operation.
1 = Fault F081	Trips as fault. Disables the motor.
2 = Alarm A081	Trips as alarm. It is just indicated.

C5.4.2 Overpower
C5.4.2.2 Level

Range:	0 ... 99 %Pn	Default: 30
Properties:	Stopped	

Description:

Level for the overpower protection tripping. It means how many % above the rated one it must trip. Ex.: 10% = motor rated power + 10%.

C5.4.2 Overpower
C5.4.2.3 Time

Range:	1 ... 99 s	Default: 1
Properties:	Stopped	

Description:

Overpower protection tripping time.

The active over- and underpower values are adjusted as a percentage of the motor rated power C2.4.

$$\text{underpower (\%)} = \left(\frac{C2.4 - S1.5.1}{C2.4} \right) \times 100\%$$

$$\text{overpower (\%)} = \left(\frac{S1.5.1 - C2.4}{C2.4} \right) \times 100\%$$

S1.5.1 is the actual active power and C2.4 is the motor rated power.

C5.4.1.2 adjusts the active underpower level that the motor can withstand during the period adjusted in C5.4.1.3, after which the SSW executes the action programmed in C5.4.1.1. It can be used in applications with hydraulic pumps that cannot operate without load.

C5.4.2.2 adjusts the active overpower level that the motor can withstand during the period adjusted in C5.4.2.3, after which the SSW executes the action programmed in C5.4.2.1.

NOTE!

These functions are active only with full voltage, after the motor starting.

C5.5 Phase Sequence

Its function is to protect loads that can rotate only in one direction.

If enabled, the phase sequence is detected every time the motor is started. It is usually used with hydraulic pump applications, which cannot rotate in the opposite direction.

C5.5 Phase Sequence
C5.5.1 Mode

Range:	0 ... 2	Default: 0
Properties:	Stopped	

Description:

When enabled it only allows the programmed phase sequence at the SSW supply line.

Indication	Description
0 = Inactive	No tripping.
1 = RST - Fault F067	Trips as fault. Only allows the phase sequence R/1L1, S/3L2, T/5L3.
2 = RTS - Fault F068	Trips as fault. Only allows the phase sequence R/1L1, T/5L3, S/3L2.

C5.6 Bypass Protections

It allows configuring the SSW bypass protections.

C5.6 Bypass Protections
C5.6.1 Undercurrent

Range:	0 ... 1	Default: 1
Properties:	Stopped	

Description:

This function, when enabled, ensures protection against undercurrent before bypass closing.

Indication	Description
0 = Inactive	No tripping.
1 = Fault F076	Trips as fault. Disables the motor.

This protection prevent the bypass closing in case of any supply line fault of any thyristor fault. When this function is disabled, the motor can be started with nominal current lower than 10% of the nominal SSW current.

NOTE!

This function should be disabled only when motors with low currents are tested.

C5.6 Bypass Protections
C5.6.2 Overcurrent

Range:	0 ... 1	Default: 1
Properties:	Stopped	

Description:

When this function is enabled it ensures protection against locked rotor at the end of the start.

Indication	Description
0 = Inactive	No tripping.
1 = Fault F063	Trips as fault. Disable the motor.

This protection prevents the bypass closing when an overcurrent two times the nominal motor current is detected.

NOTE!

Disable this function only when the motor can withstand loads with higher currents.

C5.6 Bypass Protections
C5.6.3 Closed

Range:	0 ... 1	Default: 1
Properties:	Stopped	

Description:

Its function is to indicate imperfection in the opening of the bypass contactor when the motor has been switch off.

Indication	Description
0 = Inactive	No tripping.
1 = Fault F077	Trips as fault. Disable the motor.

This protection acts with bypass internal or external.

NOTE!

Disable this protection only to make possible the use of the SSW in multimotor applications, that is, when a SSW starts more than a motor.

C5.7 Time Protections

It allows configuring some waiting time protections to start the motor.

C5.7 Time Protections		
C5.7.1 Before Start		
Range:	0.5 ... 999.9 s	Default: 0.5
Properties:	Stopped	

Description:

This protection operates by delaying the motor start for the programmed time.

After receiving the RUN command, from any command source, it waits for the programmed time to start the motor. For protection the minimum time is 0.5s.

C5.7 Time Protections		
C5.7.2 After Stop		
Range:	2.0 ... 999.9 s	Default: 2.0
Properties:	Stopped	

Description:

This protection does not allow the start for a certain time after the command to stop the motor or the end of the deceleration ramp if it is programmed.

The RUN commands, from any command source, are reset during this time. Thus, they must be resent after this time. For protection, the minimum time is 2s.

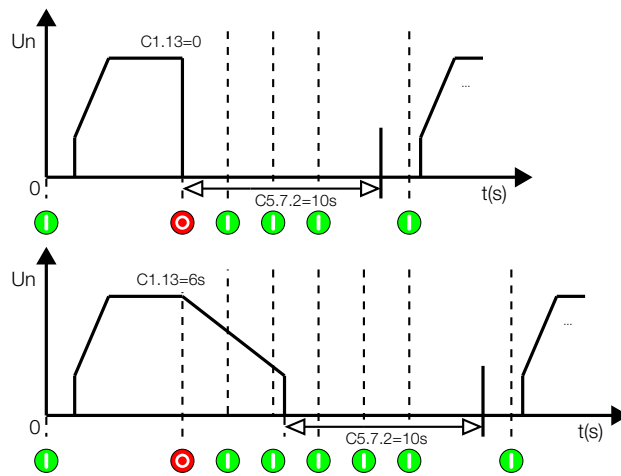

Figure 11.16: Start via HMI.

If the commands are via three-wire digital input, the RUN command will be reset. If it is via two wires and the digital input remains activated until the end of the time, the motor will start.

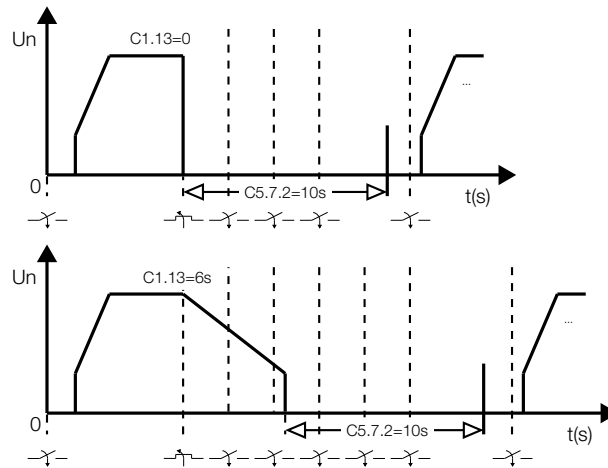

Figure 11.17: Start via three-wire digital inputs (DI1 and DI2).

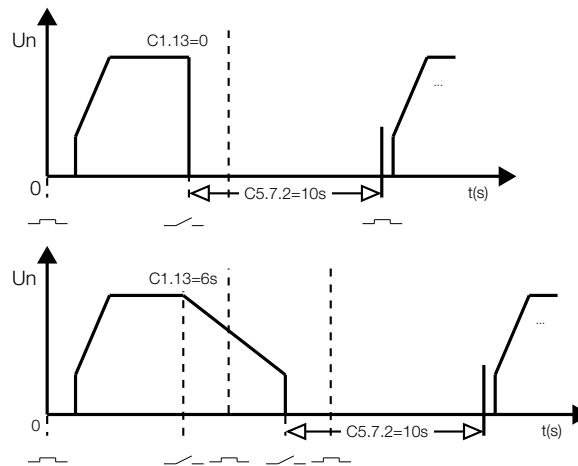

Figure 11.18: Start via digital input (DI1).

C5.7 Time Protections

C5.7.3 Between Start

Range: 2 ... 9999 s

Default: 120

Properties: Stopped

Description:

This protection operates by limiting the minimum interval between starts or between start commands.

If the SSW receives a start command before this interval ends, a fault will occur.



NOTE!

Reduce this time, below the standard 120s, only in application where the SSW is oversized or with light loads.

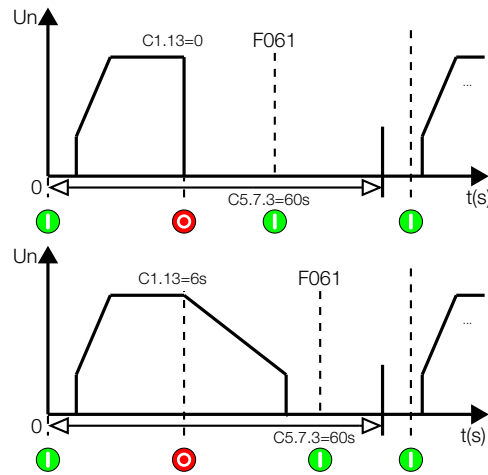

Figure 11.19: Time between starts.

C5.8 Motor Thermal Protection

Its function is to protect the motor thermally by reading its temperature through PT100 accessory.

The temperature is measured through PT100 sensors. To be able to use the motor thermal protection via PT100 sensors, it is necessary to use the PT100 accessory.

Each channel has four configuring parameters, described below:

Mode:

Not used channels must be programmed as Inactive (0). Channels programmed as Inactive show zero degrees Celsius in the correspondent temperature indicating parameter S4.3.

In the event of overtemperature, if the protection is programmed for fault, the motor is deactivated and the fault message is presented on the HMI. If it is programmed for alarm, the motor keeps running and the alarm message is presented on the HMI display. The third possibility is the use of both the options, fault and alarm.

Fault Level:

Usually a value 10% below the motor insulation class is used.

If the motor temperature reading exceeds the programmed level and the correspondent channel is programmed for fault, the motor is deactivated and the fault message is presented on the HMI.

Alarm Level:

Usually a value 20% below the motor insulation class is used.

If the motor temperature exceeds the programmed level and the correspondent channel is programmed for alarm, the motor keeps running and the alarm message is presented on the HMI display.



NOTE!

The value programmed for the overtemperature alarm activation must be higher than the value programmed for the alarm reset.

Alarm Reset:

Usually a value 30% below the motor insulation class is used.

If the motor overtemperature alarm is active and the temperature drops to a value lower than the overtemperature alarm reset level, the alarm indication will be removed.



NOTE!

The value programmed for the overtemperature alarm reset must be lower than the value programmed for the alarm activation.

C5.8.1 Ch1 Installed Sensor

This function enables the sensor fault and overtemperature protections. It also allows to identify if the sensor has been installed in the motor stator.

C5.8.1 Ch1 Installed Sensor

C5.8.1.1 Mode

Range: 0 ... 2 **Default:** 0
Properties: Stopped

Description:

It enables the actuation of the protections via temperature sensors and allows to identify if the sensor was installed in the motor stator.

Indication	Description
0 = Off	Sensor nicht installiert.
1 = On	Sensor installed.
2 = On Stator	Sensor installed in the motor stator.

C5.8.2 Ch1 Sensor Fault

This function detects either shorted or open sensor.

C5.8.2 Ch1 Sensor Fault

C5.8.2.1 Mode

Range: 0 ... 1 **Default:** 0
Properties: Stopped

Description:

It programs the tripping mode of the failure detection in the temperature sensors.

Indication	Description
0 = Fault F109 and F117	Trips as fault. Disables the motor.
1 = Alarm A109 and A117	Trips as alarm. It is just indicated.

C5.8.3 Ch1 Overtemperature

It allows configuring the motor overtemperature protection.

C5.8.3 Ch1 Overtemperature

C5.8.3.1 Mode

Range: 0 ... 2 **Default:** 0
Properties: Stopped

Description:

It programs the motor overtemperature protection tripping mode.

Indication	Description
0 = Fault F101	Trips as fault. Disables the motor.
1 = Alarm A101	Trips as alarm. It is just indicated.
2 = F101 and A101	Trips as alarm in a lower level, and as fault in the maximum level.

C5.8.3 Ch1 Overtemperature
C5.8.3.2 Fault Level

Range:	0 ... 250 °C	Default: 139
Properties:	Stopped	

Description:

It programs the maximum temperature level at which the motor can run without problems.

C5.8.3 Ch1 Overtemperature
C5.8.3.3 Alarm Level

Range:	0 ... 250 °C	Default: 124
Properties:	Stopped	

Description:

It programs the tripping level of the motor overtemperature alarm.

C5.8.3 Ch1 Overtemperature
C5.8.3.4 Alarm Reset

Range:	0 ... 250 °C	Default: 108
Properties:	Stopped	

Description:

It programs the reset level of the motor overtemperature alarm.

C5.8.4 Ch2 Installed Sensor

This function enables the sensor fault and overtemperature protections. It also allows to identify if the sensor has been installed in the motor stator.

C5.8.4 Ch2 Installed Sensor
C5.8.4.1 Mode

Range:	0 ... 2	Default: 0
Properties:	Stopped	

Description:

It enables the actuation of the protections via temperature sensors and allows to identify if the sensor was installed in the motor stator.

Indication	Description
0 = Off	Sensor nicht installiert.
1 = On	Sensor installed.
2 = On Stator	Sensor installed in the motor stator.

C5.8.5 Ch2 Sensor Fault

This function detects either shorted or open sensor.

C5.8.5 Ch2 Sensor Fault
C5.8.5.1 Mode

Range:	0 ... 1	Default: 0
Properties:	Stopped	

Description:

It programs the tripping mode of the failure detection in the temperature sensors.

Indication	Description
0 = Fault F110 and F118	Trips as fault. Disables the motor.
1 = Alarm A110 and A118	Trips as alarm. It is just indicated.

C5.8.6 Ch2 Overtemperature

It allows configuring the motor overtemperature protection.

C5.8.6 Ch2 Overtemperature
C5.8.6.1 Mode

Range:	0 ... 2	Default: 0
Properties:	Stopped	

Description:

It programs the motor overtemperature protection tripping mode.

Indication	Description
0 = Fault F102	Trips as fault. Disables the motor.
1 = Alarm A102	Trips as alarm. It is just indicated.
2 = F102 and A102	Trips as alarm in a lower level, and as fault in the maximum level.

C5.8.6 Ch2 Overtemperature
C5.8.6.2 Fault Level

Range:	0 ... 250 °C	Default: 139
Properties:	Stopped	

Description:

It programs the maximum temperature level at which the motor can run without problems.

C5.8.6 Ch2 Overtemperature
C5.8.6.3 Alarm Level

Range:	0 ... 250 °C	Default: 124
Properties:	Stopped	

Description:

It programs the tripping level of the motor overtemperature alarm.

C5.8.6 Ch2 Overtemperature
C5.8.6.4 Alarm Reset

Range:	0 ... 250 °C	Default: 108
Properties:	Stopped	

Description:

It programs the reset level of the motor overtemperature alarm.

C5.8.7 Ch3 Installed Sensor

This function enables the sensor fault and overtemperature protections. It also allows to identify if the sensor has been installed in the motor stator.

C5.8.7 Ch3 Installed Sensor

C5.8.7.1 Mode

Range:	0 ... 2	Default: 0
Properties:	Stopped	

Description:

It enables the actuation of the protections via temperature sensors and allows to identify if the sensor was installed in the motor stator.

Indication	Description
0 = Off	Sensor nicht installiert.
1 = On	Sensor installed.
2 = On Stator	Sensor installed in the motor stator.

C5.8.8 Ch3 Sensor Fault

This function detects either shorted or open sensor.

C5.8.8 Ch3 Sensor Fault

C5.8.8.1 Mode

Range:	0 ... 1	Default: 0
Properties:	Stopped	

Description:

It programs the tripping mode of the failure detection in the temperature sensors.

Indication	Description
0 = Fault F111 and F119	Trips as fault. Disables the motor.
1 = Alarm A111 and A119	Trips as alarm. It is just indicated.

C5.8.9 Ch3 Overtemperature

It allows configuring the motor overtemperature protection.

C5.8.9 Ch3 Overtemperature

C5.8.9.1 Mode

Range:	0 ... 2	Default: 0
Properties:	Stopped	

Description:

It programs the motor overtemperature protection tripping mode.

Indication	Description
0 = Fault F103	Trips as fault. Disables the motor.
1 = Alarm A103	Trips as alarm. It is just indicated.
2 = F103 and A103	Trips as alarm in a lower level, and as fault in the maximum level.

C5.8.9 Ch3 Overtemperature
C5.8.9.2 Fault Level

Range:	0 ... 250 °C	Default: 139
Properties:	Stopped	

Description:

It programs the maximum temperature level at which the motor can run without problems.

C5.8.9 Ch3 Overtemperature
C5.8.9.3 Alarm Level

Range:	0 ... 250 °C	Default: 124
Properties:	Stopped	

Description:

It programs the tripping level of the motor overtemperature alarm.

C5.8.9 Ch3 Overtemperature
C5.8.9.4 Alarm Reset

Range:	0 ... 250 °C	Default: 108
Properties:	Stopped	

Description:

It programs the reset level of the motor overtemperature alarm.

C5.8.10 Ch4 Installed Sensor

This function enables the sensor fault and overtemperature protections. It also allows to identify if the sensor has been installed in the motor stator.

C5.8.10 Ch4 Installed Sensor
C5.8.10.1 Mode

Range:	0 ... 2	Default: 0
Properties:	Stopped	

Description:

It enables the actuation of the protections via temperature sensors and allows to identify if the sensor was installed in the motor stator.

Indication	Description
0 = Off	Sensor nicht installiert.
1 = On	Sensor installed.
2 = On Stator	Sensor installed in the motor stator.

C5.8.11 Ch4 Sensor Fault

This function detects either shorted or open sensor.

C5.8.11 Ch4 Sensor Fault
C5.8.11.1 Mode

Range:	0 ... 1	Default: 0
Properties:	Stopped	

Description:

It programs the tripping mode of the failure detection in the temperature sensors.

Indication	Description
0 = Fault F112 and F120	Trips as fault. Disables the motor.
1 = Alarm A112 and A120	Trips as alarm. It is just indicated.

C5.8.12 Ch4 Overtemperature

It allows configuring the motor overtemperature protection.

C5.8.12 Ch4 Overtemperature

C5.8.12.1 Mode

Range:	0 ... 2	Default: 0
Properties:	Stopped	

Description:

It programs the motor overtemperature protection tripping mode.

Indication	Description
0 = Fault F104	Trips as fault. Disables the motor.
1 = Alarm A104	Trips as alarm. It is just indicated.
2 = F104 and A104	Trips as alarm in a lower level, and as fault in the maximum level.

C5.8.12 Ch4 Overtemperature

C5.8.12.2 Fault Level

Range:	0 ... 250 °C	Default: 139
Properties:	Stopped	

Description:

It programs the maximum temperature level at which the motor can run without problems.

C5.8.12 Ch4 Overtemperature

C5.8.12.3 Alarm Level

Range:	0 ... 250 °C	Default: 124
Properties:	Stopped	

Description:

It programs the tripping level of the motor overtemperature alarm.

C5.8.12 Ch4 Overtemperature

C5.8.12.4 Alarm Reset

Range:	0 ... 250 °C	Default: 108
Properties:	Stopped	

Description:

It programs the reset level of the motor overtemperature alarm.

C5.8.13 Ch5 Installed Sensor

This function enables the sensor fault and overtemperature protections. It also allows to identify if the sensor has been installed in the motor stator.

C5.8.13 Ch5 Installed Sensor

C5.8.13.1 Mode

Range:	0 ... 2	Default: 0
Properties:	Stopped	

Description:

It enables the actuation of the protections via temperature sensors and allows to identify if the sensor was installed in the motor stator.

Indication	Description
0 = Off	Sensor nicht installiert.
1 = On	Sensor installed.
2 = On Stator	Sensor installed in the motor stator.

C5.8.14 Ch5 Sensor Fault

This function detects either shorted or open sensor.

C5.8.14 Ch5 Sensor Fault
C5.8.14.1 Mode

Range:	0 ... 1	Default: 0
Properties:	Stopped	

Description:

It programs the tripping mode of the failure detection in the temperature sensors.

Indication	Description
0 = Fault F113 and F121	Trips as fault. Disables the motor.
1 = Alarm A113 and A121	Trips as alarm. It is just indicated.

C5.8.15 Ch5 Overtemperature

It allows configuring the motor overtemperature protection.

C5.8.15 Ch5 Overtemperature
C5.8.15.1 Mode

Range:	0 ... 2	Default: 0
Properties:	Stopped	

Description:

It programs the motor overtemperature protection tripping mode.

Indication	Description
0 = Fault F105	Trips as fault. Disables the motor.
1 = Alarm A105	Trips as alarm. It is just indicated.
2 = F105 and A105	Trips as alarm in a lower level, and as fault in the maximum level.

C5.8.15 Ch5 Overtemperature
C5.8.15.2 Fault Level

Range:	0 ... 250 °C	Default: 139
Properties:	Stopped	

Description:

It programs the maximum temperature level at which the motor can run without problems.

C5.8.15 Ch5 Overtemperature
C5.8.15.3 Alarm Level

Range:	0 ... 250 °C	Default: 124
Properties:	Stopped	

Description:

It programs the tripping level of the motor overtemperature alarm.

C5.8.15 Ch5 Overtemperature
C5.8.15.4 Alarm Reset

Range:	0 ... 250 °C	Default: 108
Properties:	Stopped	

Description:

It programs the reset level of the motor overtemperature alarm.

C5.8.16 Ch6 Installed Sensor

This function enables the sensor fault and overtemperature protections. It also allows to identify if the sensor has been installed in the motor stator.

C5.8.16 Ch6 Installed Sensor
C5.8.16.1 Mode

Range:	0 ... 2	Default: 0
Properties:	Stopped	

Description:

It enables the actuation of the protections via temperature sensors and allows to identify if the sensor was installed in the motor stator.

Indication	Description
0 = Off	Sensor nicht installiert.
1 = On	Sensor installed.
2 = On Stator	Sensor installed in the motor stator.

C5.8.17 Ch6 Sensor Fault

This function detects either shorted or open sensor.

C5.8.17 Ch6 Sensor Fault
C5.8.17.1 Mode

Range:	0 ... 1	Default: 0
Properties:	Stopped	

Description:

It programs the tripping mode of the failure detection in the temperature sensors.

Indication	Description
0 = Fault F114 and F122	Trips as fault. Disables the motor.
1 = Alarm A114 and A122	Trips as alarm. It is just indicated.

C5.8.18 Ch6 Overtemperature

It allows configuring the motor overtemperature protection.

C5.8.18 Ch6 Overtemperature
C5.8.18.1 Mode

Range:	0 ... 2	Default: 0
Properties:	Stopped	

Description:

It programs the motor overtemperature protection tripping mode.

Indication	Description
0 = Fault F106	Trips as fault. Disables the motor.
1 = Alarm A106	Trips as alarm. It is just indicated.
2 = F106 and A106	Trips as alarm in a lower level, and as fault in the maximum level.

C5.8.18 Ch6 Overtemperature
C5.8.18.2 Fault Level

Range:	0 ... 250 °C	Default: 139
Properties:	Stopped	

Description:

It programs the maximum temperature level at which the motor can run without problems.

C5.8.18 Ch6 Overtemperature
C5.8.18.3 Alarm Level

Range:	0 ... 250 °C	Default: 124
Properties:	Stopped	

Description:

It programs the tripping level of the motor overtemperature alarm.

C5.8.18 Ch6 Overtemperature
C5.8.18.4 Alarm Reset

Range:	0 ... 250 °C	Default: 108
Properties:	Stopped	

Description:

It programs the reset level of the motor overtemperature alarm.

C5.9 Motor Thermal Class

This thermal protection has curves that simulate the motor heating and cooling.

All the calculation is done by means of an algorithm that estimates the motor temperature through the true RMS current supplied to it.

The thermal protection curves are divided into two groups, the starting curves and the motor heating and cooling curves:

The starting curves, or tripping curves, are based on the locked rotor time that the motor withstands with a certain current (Figure 11.22). These curves simulate the motor heating in overload situations, i.e., with current above its rated current and are usually based on the IEC 60947-4-2 standard.

Even with the use of temperature sensors, the motor may not be totally protected during starting or locked rotor conditions, in which situation, due to the high currents the internal temperatures rise rapidly in a period that the sensors are not able to respond.

The heating and cooling curves for normal operation conditions simulate the motor heating and cooling with currents equal or lower than the rated value (Figure 11.25) or the cooling during the period the motor stays deactivated (Figure 11.26).

In the majority of thermal relays these heating and cooling times are fixed and in the order of a few minutes, protecting only some low power motors.

The thermal class protection can be configured in two ways: standard or customized. The customized mode is totally flexible, and it can be configured to protect and allow the starting of special motors, which present long starting times and high starting currents.

C5.9 Motor Thermal Class

C5.9.1 Programming Mode

Range:	0 ... 1	Default: 0
Properties:	Stopped	

Description:

It allows programming the motor thermal class protection tripping mode.

Indication	Description
0 = Standard	Standardized according to IEC 60947-4-2.
1 = Custom	Requires the motor manufacturer data.

The Figure 11.20 shows the programming sequence necessary for the correct operation of the motor thermal class protection in the standard programming mode.

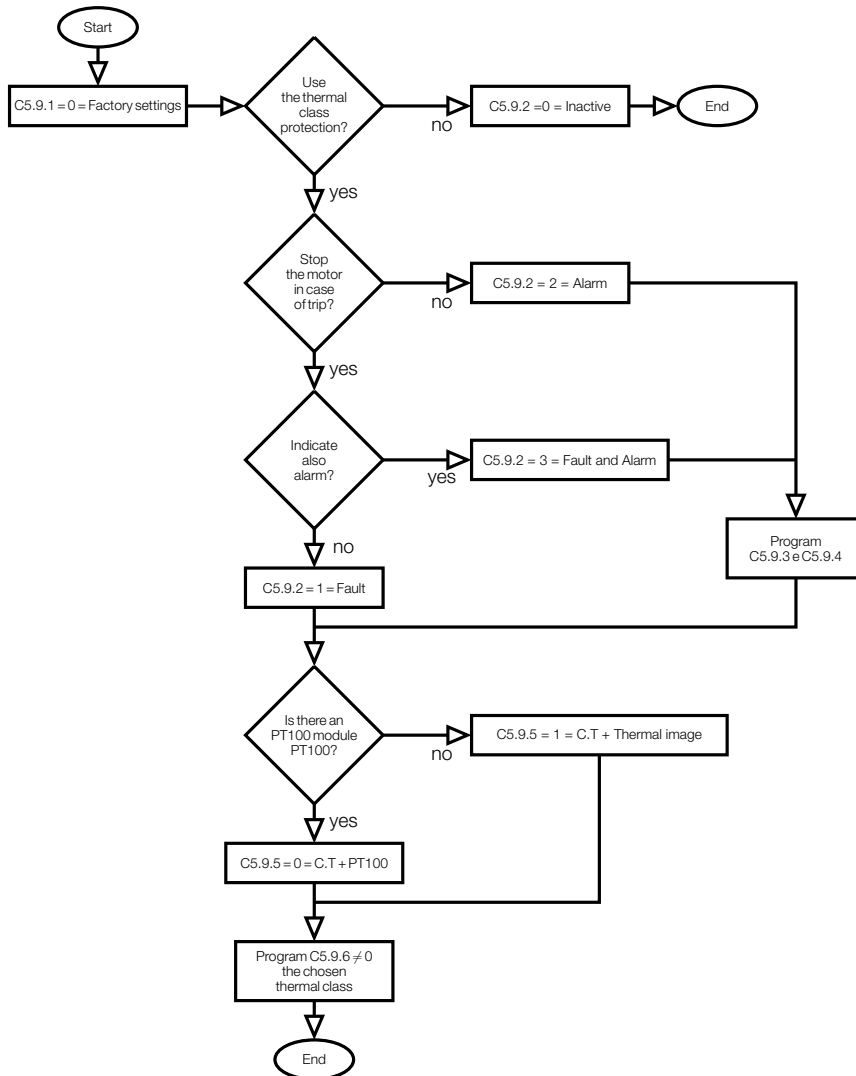

Figure 11.20: Thermal Class Protection programming sequence - standard mode.

The Figure 11.21 shows the programming sequence to customize the thermal class tripping to suit special applications or motors.

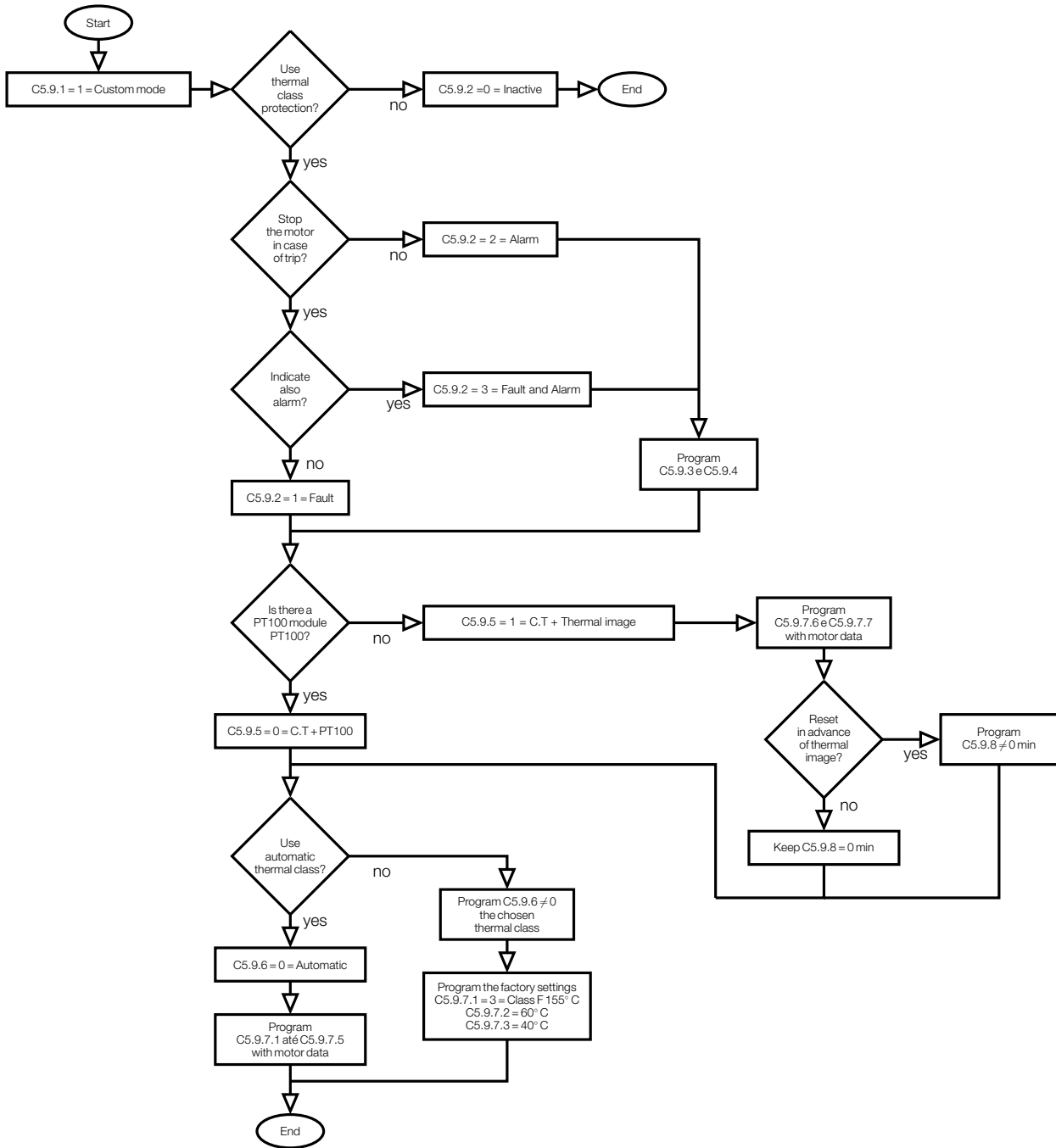

Figure 11.21: Thermal Class Protection programming sequence - customized mode.

To program properly in the customized mode, it is necessary to have the motor manufacturer data.



NOTE!

Whenever you change the programming mode from customized to standard, all programmed data out of the standard established by IEC 60947-4-2 will be modified.

C5.9 Motor Thermal Class

C5.9.2 Action Mode

Range: 0 ... 3

Default: 1

Properties: Stopped

Description:

Program the motor thermal class protection tripping mode.

Indication	Description
0 = Inactive	No tripping.
1 = Fault F005	Trips as fault. Disables the motor.
2 = Alarm A005	Trips as alarm. It is just indicated.
3 = F005 and A005	Trips as alarm at a lower level, and as fault at maximum level.

If it is programmed for fault or for fault and alarm, the motor is deactivated and the fault message is presented on the HMI when the overload protection reaches the value of 100% of the programmed tripping class thermal capacity.

If it is programmed for alarm, the motor keeps running and the alarm message is presented on the HMI display when the overload value reaches the alarm limit programmed in Alarm Level C5.9.3. The alarm indication is removed only when the overload value drops below the value programmed for reset, in Alarm Reset C5.9.4.

C5.9 Motor Thermal Class
C5.9.3 Alarm Level

Range:	0 ... 100 %	Default: 90
Properties:	Stopped	

Description:

It indicates alarm when it is above this value.

C5.9 Motor Thermal Class
C5.9.4 Alarm Reset

Range:	0 ... 100 %	Default: 84
Properties:	Stopped	

Description:

It resets the alarm when it is below this value.

C5.9 Motor Thermal Class
C5.9.5 Motor Temperature

Range:	0 ... 1	Default: 1
Properties:	Stopped	

Description:

It programs if the motor temperature is obtained through measurement or thermal image.

Indication	Description
0 = T.C. + PT100	Thermal class together with the PT100.
1 = T.C. + Th.Im.	Thermal class together with the motor Thermal Image.

Thermal class together with the PT100 temperature measurement: protect in starting and overload situations by means of the thermal class referenced to the real motor temperatures, that is, the hot starting times are proportional to the real motor temperature. The motor heating and cooling are done through the real motor temperatures from Ch1 to Ch3 PT100.

Thermal class together with the Thermal Image: protect in starting and overload situations through the thermal class referenced to the motor thermal image. The heating and cooling are done through the motor thermal image.

The thermal image is a motor temperature estimation achieved by means of the thermal modeling, based on the current measurement.

The standard programming mode uses the heating and cooling constants for a standard motor, and they are based on the motor power.

The customized programming mode uses the heating (C5.9.8.6) and cooling (C5.9.8.7) constants provided by the motor manufacturer.



WARNING!

In the Thermal Class and PT100 Temperature mode, you must use the module channels Ch1 to Ch3 to measure the stator temperature, and channels Ch4 and Ch5 to measure the bearing temperature of the motor.

C5.9 Motor Thermal Class

C5.9.6 Thermal Class

Range:	0 ... 8	Default: 5
Properties:	Stopped	

Description:

Standard motor thermal classes.

Indication	Description
0 = Automatic	Automatic choice of the Time x Current curve.
1 = Class 10	Class 10 Time x Current Curve.
2 = Class 15	Class 15 Time x Current Curve.
3 = Class 20	Class 20 Time x Current Curve.
4 = Class 25	Class 25 Time x Current Curve.
5 = Class 30	Class 30 Time x Current Curve.
6 = Class 35	Class 35 Time x Current Curve.
7 = Class 40	Class 40 Time x Current Curve.
8 = Class 45	Class 45 Time x Current Curve.

The Figure 11.22 presents the thermal class times according to the IEC 60947-4-2 standard.

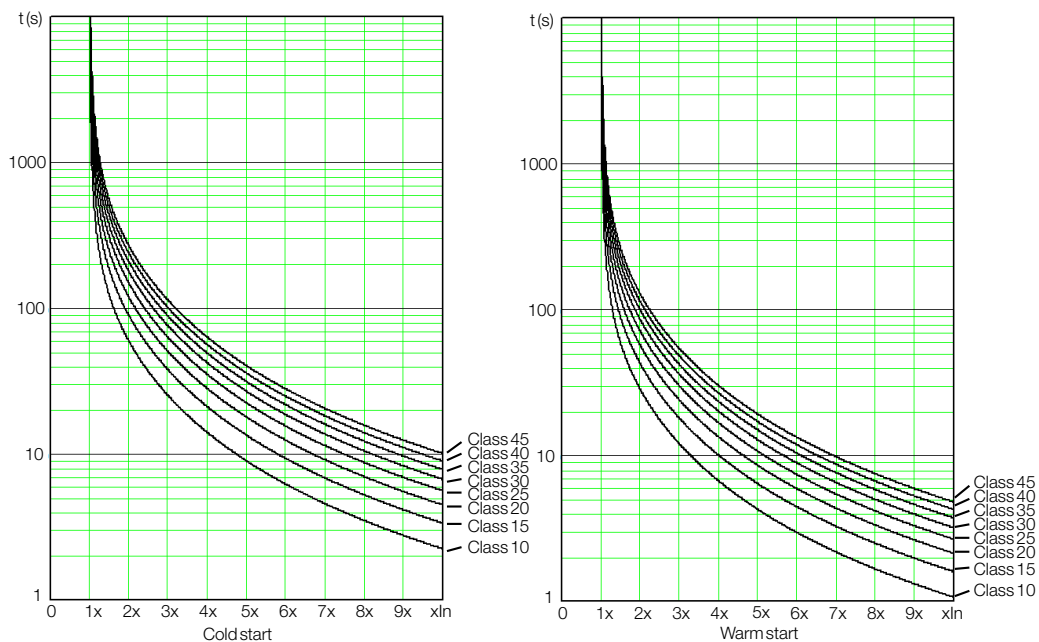

Figure 11.22: Standard motor thermal classes.

Thermal Classes from 10 to 45:

The thermal class that better adapts for the motor protection can be chosen, allowing its starting, as well as to protect certain parts of the motor feeding system.

The standard starting cold curves, shown in Figure 11.23, consider the motor cold temperature as ambient temperature, C5.9.7.3 = 40°C. That is, the cold motor temperature is ambient temperature of 40 °C.

WARNING!

The following data are only available in the customized programming mode. Use this mode only if you are qualified and have the data provided by the motor manufacturer.

NOTE!

In the customized programming mode: to use the Thermal Classes 10 to 45, standardized, the factory settings of the parameters must be kept, C5.9.7.1 = 3 = Class F 155 °C, C5.9.7.2 = 60 °C and C5.9.7.3 = 40 °C.

Automatic Thermal Class:

The thermal class is calculated automatically, through the hot locked rotor current (C5.9.7.5) and the hot locked rotor time (C5.9.7.4). The thermal class is calculated approximately 10% below the motor thermal limit. Therefore, this tripping class is only for the motor protection, not taking into account the motor feeding electric system capacity.

NOTE!

To be able to use the Automatic Thermal Class, C5.9.6 = 0 = Automatic, it is necessary to program the heating time constant C5.9.7.6 and cooling time constant C5.9.7.7 according to the data supplied by the motor manufacturer.

C5.9.7 Motor Data

It sets the Thermal Class according to the data provided by the motor manufacturer.

Through the data provided by the motor manufacturer, you can define the Thermal Class operation, according to the thermal capacity of the motor used, mainly for special motors.

C5.9.7 Motor Data
C5.9.7.1 Insulation Class

Range: 0 ... 8 **Default:** 3
Properties: Stopped

Description:

It defines insulation class of the insulating material used to produce the motor.

Indication	Description
0 = Class A 105°C	Maximum temperature of 105°C.
1 = Class E 120°C	Maximum temperature of 120°C.
2 = Class B 130°C	Maximum temperature of 130°C.
3 = Class F 155°C	Maximum temperature of 155°C. Standardized in the standard programming mode.
4 = Class H 180°C	Maximum temperature of 180°C.
5 = Class N 200°C	Maximum temperature of 200°C.
6 = Class R 220°C	Maximum temperature of 220°C.
7 = Class S 240°C	Maximum temperature of 240°C.
8 = Class 250°C	Maximum temperature of 250°C.

C5.9.7 Motor Data
C5.9.7.2 Temperature Rise

Range: 0 ... 200 °C **Default:** 60
Properties: Stopped

Description:

It defines the motor temperature variation, Δt , when submitted to full load.

C5.9.7 Motor Data

C5.9.7.3 Ambient Temperature

Range:	0 ... 200 °C	Default: 40
Properties:	Stopped	

Description:

It defines operating temperature for which the motor has been designed.

The factory settings for the parameters, C5.9.7.1 = 3 = Class F 155 °C, C5.9.7.2 = 60 °C and C5.9.7.3 = 40 °C, define the tripping times showed in the Figure 11.23. for thermal classes according to the IEC 60947-4-2 standard. These times are based on the typical characteristics of market standard motors, thus not being adequate to allow the starting of special motors, which have higher insulation classes, longer starting times with high currents and a variety of cooling system types.

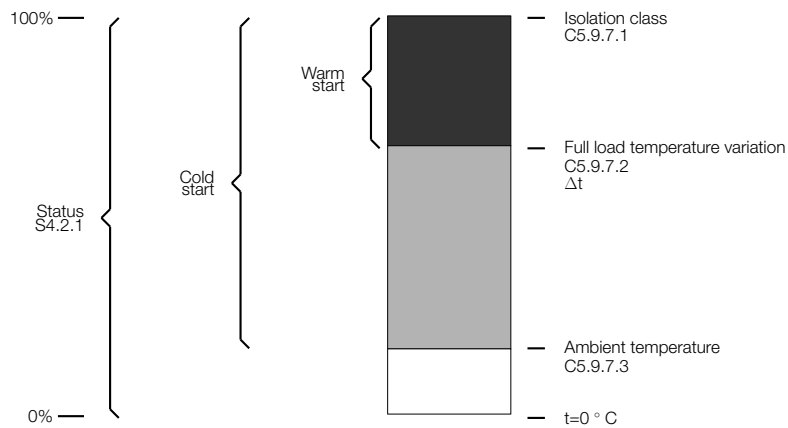

Figure 11.23: Motor temperature regions within the insulation class.

C5.9.7 Motor Data

C5.9.7.4 Locked Rotor Time

Range:	1 ... 100 s	Default: 10
Properties:	Stopped	

Description:

It adjusts the hot locked rotor time that the motor withstands.

C5.9.7 Motor Data

C5.9.7.5 Locked Rotor Current

Range:	2.0 ... 10.0 x	Default: 6.0
Properties:	Stopped	

Description:

It adjusts the motor locked rotor current.

Through the hot locked rotor time C5.9.7.4 and hot locked rotor current C5.9.7.5, you can use the Thermal Class automatic calculation function, C5.9.6 = 0 = Automatic, employing the data provided by the motor manufacturer.

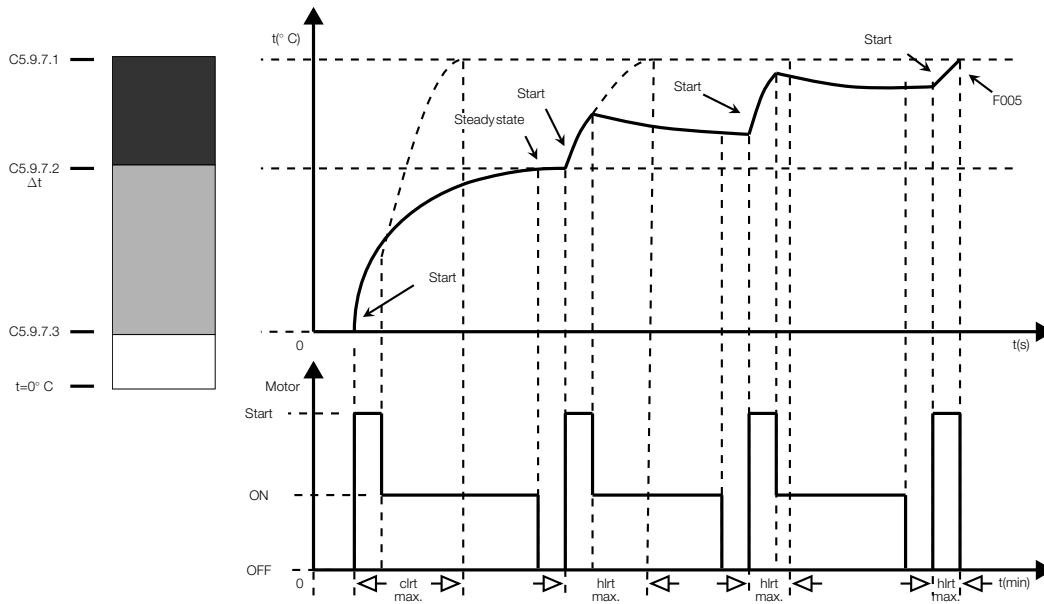

Figure 11.24: Motor heating.

The Figure 11.24 shows the warming up of a motor caused by a working cycle with several starts.

At the first start the motor is at ambient temperature, thus withstanding a longer locked rotor time (clrt = cold locked rotor time).

The second start occurs soon after switching off the motor, which was already operating at full load and with stabilized temperature. Therefore, the available time for a new start is the hot locked rotor time (hlrt).

At the third start, the available time is shorter than the hlrt because of the heating caused by the second start.

However, because of the excessive heating caused by the previous starts, which occurred without giving the necessary time for cooling the motor, at the fourth start the overload protection trips.



NOTE!

To be able to use the Automatic Thermal Class, C5.9.6 = 0 = Automatic, it is necessary to program C5.9.7.4 and C5.9.7.5 according to the data supplied by the motor manufacturer.

C5.9.7 Motor Data

C5.9.7.6 Heating Time Constant

Range: 1 ... 2880 min

Default: 30

Properties: Stopped

Description:

It defines the motor heating thermal constant.

C5.9.7 Motor Data

C5.9.7.7 Cooling Time Constant

Range: 1 ... 8640 min

Default: 93

Properties: Stopped

Description:

It defines the motor cooling thermal constant.

The heating and cooling times of a motor depend on several factors, such as its mass, power, total heat dissipation area, cooling type and room temperature. Therefore, in order to get a thermal image close to the actual motor temperature, it is necessary to program the heating and cooling thermal constant times supplied by the motor manufacturer.

The motor heating constant is shown in Figure 11.25.

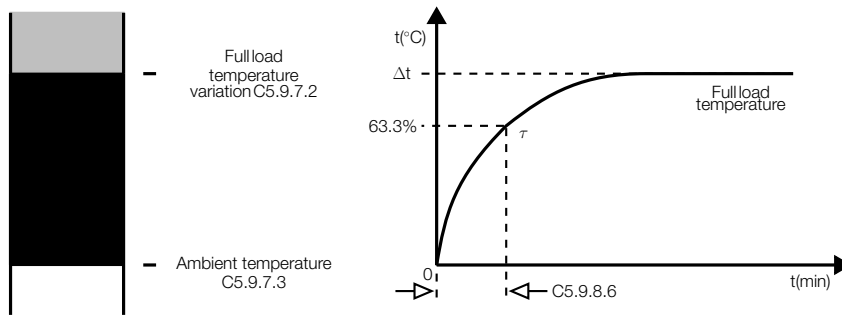

Figure 11.25: Motor heating constant for rated current.

The motor cooling constant is shown in Figure 11.26.

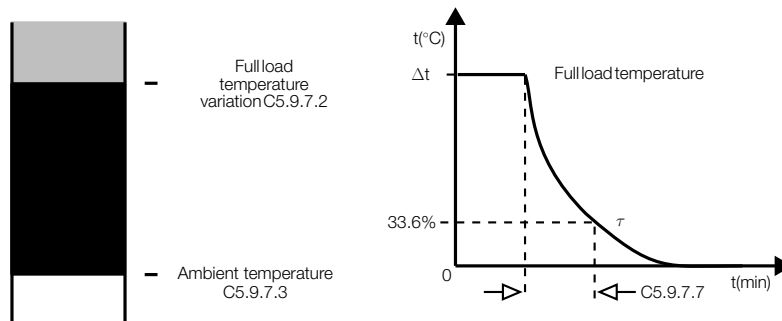

Figure 11.26: Deenergized motor cooling constant.

C5.9.8 Thermal Image

The thermal image is a motor temperature estimation achieved by means of the thermal modeling, totally based on the current measurement.

The motor thermal image value is saved in a nonvolatile memory every time the control board power supply is removed. When the control board is powered up again, the thermal image is updated according to the motor cooling during the time the control remained off, by means of the real time clock information.

C5.9.8 Thermal Image		
C5.9.8.1 Reset		
Range:	0 ... 8640 min	Default: 0
Properties:	Stopped	

Description:

It allows resetting or erasing the motor thermal image in advance.

It defines a time to reset the motor thermal image. It can be used to reset the thermal image after a period with the motor switched off, as showed in the Figure 11.27.

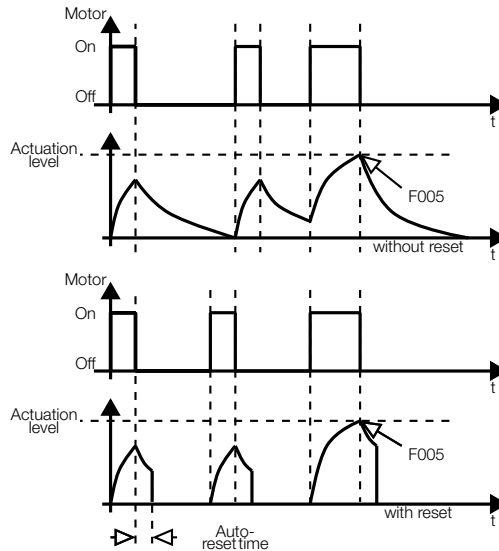

Figure 11.27: Motor thermal image reset.

C5.10 SSW Short Circuit

Its function is to detect some short circuit in the SSW power section, thyristors, bypass, cables or motor.

C5.10 SSW Short Circuit		
C5.10.1 Motor Off		
Range:	0 ... 1	Default: 0
Properties:	Stopped	

Description:

Protection against short circuit on the SSW power section. It trips with the motor stopped.

Indication	Description
0 = Inactive	No tripping.
1 = Fault F019	Trips as fault. Disables the motor.

Its function is to protect the motor when a short circuit occurs on the SSW power circuit, thyristors or bypass with the motor stopped, that is, without the Run command.

This protection trips when some of the RMS three-phase current is at a value above 25% of the SSW rated current C9.1.1 with the motor stopped. And if these same phases do not present blocking voltage S1.4. by a period longer than 50ms (0.25 x InSSW @ 50ms).

NOTE! This protection will only be effective with the use of the contactor (K1) or main circuit breaker (Q1) for power isolation, being directed by the error output.

C5.10 SSW Short Circuit		
C5.10.2 Motor On		
Range:	0 ... 1	Default: 0
Properties:	Stopped	

Description:

Protection against short circuit on the SSW power section, cables or motor. It trips with the motor running.

Indication	Description
0 = Inactive	No tripping.
1 = Fault F020	Trips as fault. Disables the motor.

This protection trips when some of the three-phase currents remains above 5 x the SSW rated current C9.1.1 for a period longer than 0.75ms (5 x InSSW @ 0.75ms) with the motor running.

It may trip because of short circuit on the SSW power section, short circuit on the SSW cables, short circuit on the motor, locked rotor, defective motor, under momentary loads, oscillating loads.

NOTE!

This protection must only be used in applications with loads that remain within the nominal operating conditions.

NOTE!

If the short circuit in on the SSW power section, this protection will only be effective with the use of the contactor (K1) or main circuit breaker (Q1) for power isolation, being directed by the error output.

C5.11 Fault Auto-Reset

When a fault occurs, the SSW is able to reset itself automatically.

C5.11 Fault Auto-Reset
C5.11.1 Mode

Range:	0 ... 1	Default: 0
Properties:	Stopped	

Description:

It allows enabling the fault auto-reset.

Indication	Description
0 = Off	Inactive.
1 = On	Active.

C5.11 Fault Auto-Reset
C5.11.2 Time

Range:	3 ... 600 s	Default: 3
Properties:	Stopped	

Description:

Time for the fault auto-reset. This time begins after the fault occurs.

If after the auto-reset the same fault occurs again three times consecutively, the auto-reset function will be inhibited. A fault is considered consecutive if it happens again within 30 seconds after the auto reset execution.

Therefore, if a fault occurs four consecutive times, it remains being indicated (and the SSW disabled) continuously until the power is cycled.

C6 HMI

It allows changing the parameres related to the information presentation on the HMI display.

C6.1 Password

It allows configuring the password operation.

C6.1 Password		
C6.1.1 Password		
Range:	0 ... 9999	Default: 0
Properties:		

Description:

It allows access to change all SSW configuration parameters.

C6.1 Password		
C6.1.2 Password Options		
Range:	0 ... 2	Default: 1
Properties:		

Description:

It allows changing the password value and/or setting its status, configuring it as active or inactive.

Indication	Description
0 = Off	No password.
1 = On	With password.
2 = Change Password	Enables password change.

When option 2 is selected (Change Password), the HMI opens a window to change the password, enabling the selection of a new value for the it.

C6.2 Language

It determines the language in which the information will be displayed on the HMI.

C6.2 Language		
C6.2.1 Language		
Range:	0 ... 2	Default: 1
Properties:		

Description:

It determines the language in which the information will be displayed on the HMI.

Indication	Description
0 = Português	Portuguese.
1 = English	English.
2 = Español	Spanish.
3 = Deutsch	German.

C6.3 Date and Time

These parameters set the date and time of the SSW real time clock.

C6.3 Date and Time
C6.3.1 Date and Time

Range: yy-mm-dd hh:mm:ss
Properties:

Description:

These parameters set the date and time of the SSW RTC (Real Time Clock).

It is important to set the correct date and time to record the fault with actual date and time information.

C6.3 Date and Time
C6.3.2 Day of the Week

Range: 0 ... 6 **Default:** 0
Properties:

Description:

This parameter sets the SSW real time day of the week.

Indication	Description
0 = Sunday	Sunday.
1 = Monday	Monday.
2 = Tuesday	Tuesday.
3 = Wednesday	Wednesday.
4 = Thursday	Thursday.
5 = Friday	Friday.
6 = Saturday	Saturday.

C6.4 Main Screen

These parameters allow programming what will be displayed on the main monitoring screen.

The programming is done by selecting directly on the menu whose content you wish to display.

Only the Status numeric reading parameters are displayed. When you select a parameter whose content cannot be displayed, the respective area will be empty.

C6.5 LCD Backlight

It allows setting the backlight level of the HMI display.

C6.5 LCD Backlight
C6.5.1 Level

Range: 1 ... 15 **Default:** 10
Properties:

Description:

Higher values configure a higher backlight of the HMI display.

C6.6 Communication Timeout

It allows configuring a protection against loss of communication with the HMI.

C6.6 Communication Timeout
C6.6.1 Mode

Range:	0 ... 2	Default: 2
Properties:	Stopped	

Description:

It allows configuring the tripping mode of the protection against timeout of the communication with the HMI.

Indication	Description
0 = Inactive	No tripping.
1 = Fault F127	Trips as fault. Disables the motor.
2 = Alarm A127	Trips as alarm. Action defined in C6.6.2.

C6.6 Communication Timeout
C6.6.2 Alarm Action

Range:	0 ... 4	Default: 1
Properties:	Stopped	

Description:

Action for the alarm of timeout of the communication with HMI.

Indication	Description
0 = Indicates Only	No action is taken; the equipment remains in the current state.
1 = Ramp Stop	The stop by ramp command is executed, and the motor stops according to the programmed deceleration ramp.
2 = General Disable	The equipment is general disabled, and the motor stops by inertia.
3 = Change to LOC	The equipment is commanded to local mode.
4 = Change to REM	The equipment is commanded to remote mode.

C6.6 Communication Timeout
C6.6.3 Time

Range:	1 ... 999 s	Default: 3
Properties:		

Description:

Maximum time without communication with the HMI.

Normally, the HMI send 3 telegrams per second.

C7 SPECIAL FUNCTIONS

It allows configuring special operating functions of the SSW.

C7.1 Forward/Reverse

It makes possible the control of the rotation direction change.

C7.1 Forward/Reverse
C7.1.1 Mode

Range:	0 ... 2	Default: 0
Properties:	Stopped	

Description:

It enables and selects the type of motor rotation direction change.

Indication	Description
0 = Inactive	No tripping.
1 = By Contactor	Changes the rotation direction trough the contactors connected to the power supply input.
2 = Only for JOG	Allows starting the motor at low speed in both rotation direction.

By Contactor:

This option allows the rotation direction reversion through contactors connected at the line supply.

The method implemented in SSW allows the use of only two contactors for simultaneously alternating the rotation direction and isolating the power section from the supply line.

When the motor is stopped, both contactors stay open. When the motor is started, the respective contactor is closed.

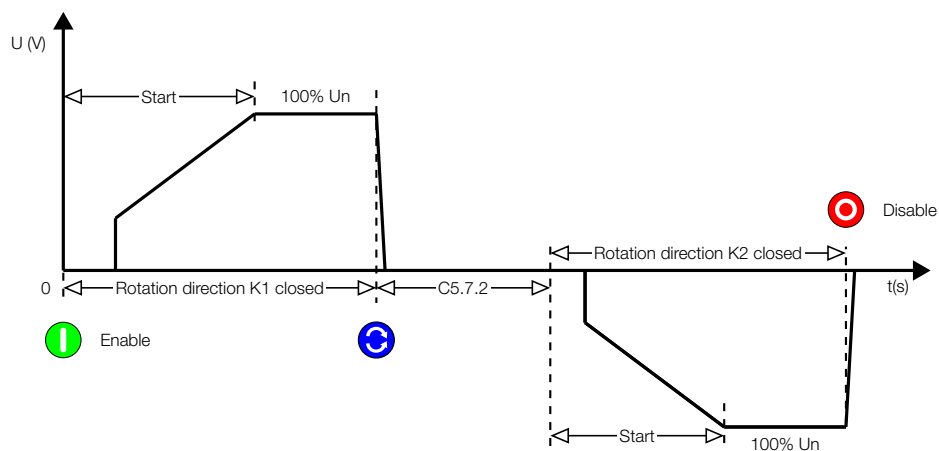

Figure 11.28: Motor rotation direction change via contactors.

NOTE!

The method used to restart the motor is the same used to start it in the other rotation direction.

NOTE!

The motor will only start again after the time programmed in C5.7.2 has elapsed (Time Interval after Motor Stopping).

Only JOG:

This option allows the activation of the motor at low speed in both rotation directions without the need of using contactors.

For more information, refer to the parameters C7.3.1 and C7.3.2.

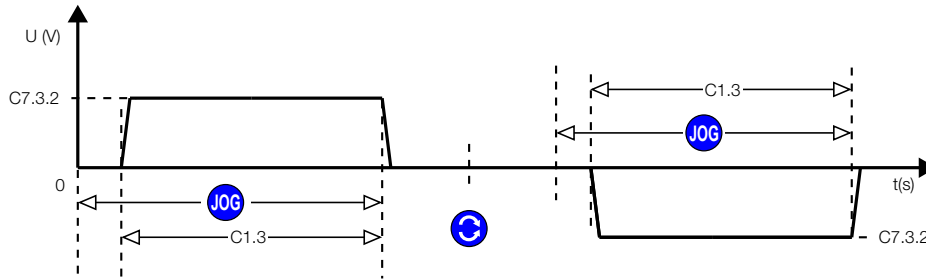

Figure 11.29: Motor rotation direction change only with JOG.

C7.2 Kick Start

The SSW900 makes possible the use of a torque pulse for starting-up loads that present high initial resistance to the movement.

C7.2 Kick Start		
C7.2.1 Mode		
Range:	0 ... 1	Default: 0
Properties:	Stopped	

Description:

It enables the starting torque pulse.

Indication	Description
0 = Off	Inactive.
1 = On	Active.

C7.2 Kick Start		
C7.2.2 Time		
Range:	0.1 ... 2.0 s	Default: 0.1
Properties:	Stopped	

Description:

Starting torque pulse time.

C7.2 Kick Start		
C7.2.3 Voltage		
Range:	70 ... 90 %	Default: 70
Properties:	Stopped	

Description:

Starting torque pulse level when it is with voltage ramp control.

C7.2 Kick Start		
C7.2.4 Current		
Range:	300 ... 700 %	Default: 500
Properties:	Stopped	

Description:

Starting torque pulse level when it is with current limit control or current ramp.

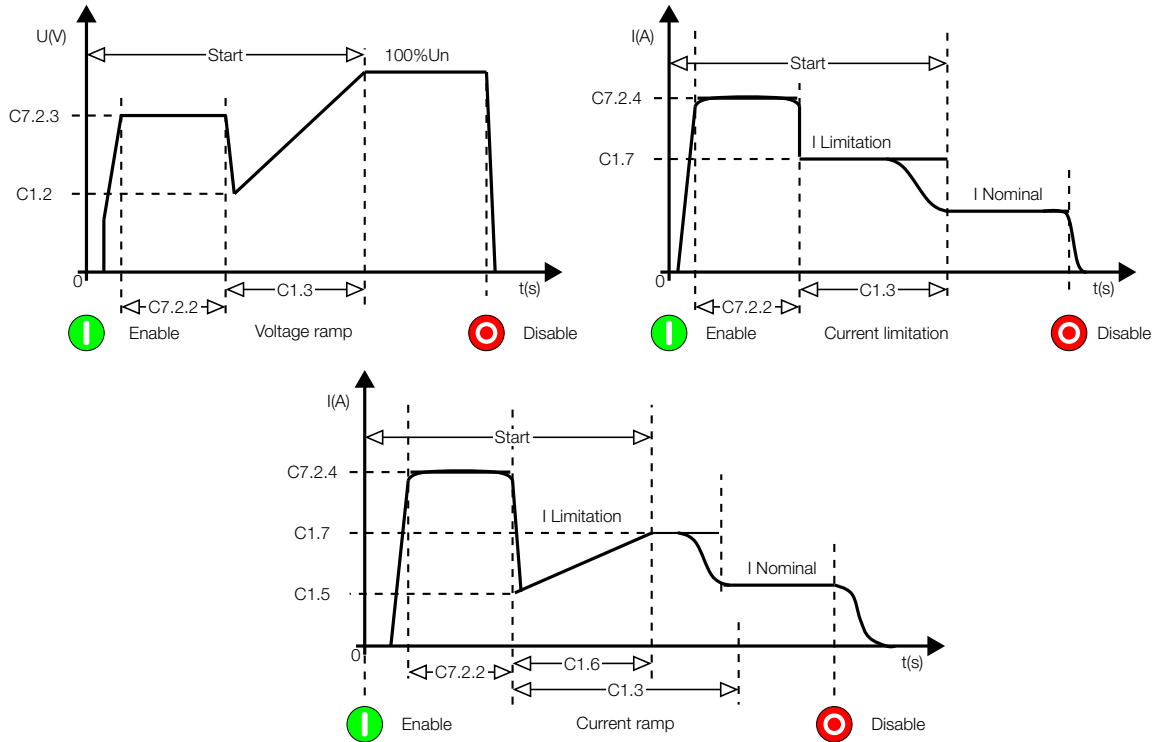

Figure 11.30: Starting torque pulse - kick start - settings.



NOTE!

1. Use this function only in specific applications where it is necessary.
2. This function is not necessary with torque control.
3. This function is not available with pump control.

C7.3 Jog

It allows running the motor at low speed.

C7.3 Jog

C7.3.1 Mode

Range: 0 ... 1

Default: 0

Properties: Stopped

Description:

This parameter enables the low speed Jog.

Indication	Description
0 = Off	Inactive.
1 = On	Active.

Low speed with Jog in the forward rotation direction is approximately 1/7 of the nominal speed.

Low speed with Jog in the reverse rotation direction is approximately 1/11 of the nominal speed.

C7.3.1	C7.1.1	Operation
0 (Inactive)	-	Without Jog.
1 (Active)	0 (Inactive)	It makes the low speed Jog possible only in forward rotation direction.
1 (Active)	1 (By Contactor)	It makes the low speed Jog, in the same rotation direction of the line, possible. Rotation direction contactors allow the rotation reversion.
1 (Active)	2 (JOG Only)	It makes the low speed Jog in both directions possible, without using contactors.

Table 11.10: Jog and motor rotation direction.

C7.3 Jog

C7.3.2 Level

Range:	10 ... 100 %	Default: 30
Properties:	Stopped	

Description:

This parameter adjusts the Jog voltage level that will be applied to the motor.



WARNING!

1. Be careful with this Jog voltage level. Program it according to the application needs, if the motor and the SSW are able to withstand it.
2. The motor can only be operated during a limited period with Jog, use a pushbutton.
3. The SSW does not protect the motor during the Jog function without using temperature sensors together with the PT100 board.



NOTE!

1. The parameter C1.3 is the Jog time limit protection. If this time is exceeded, then F062 occurs.
2. The parameters S1.1, S1.5 and S1.7 are zeroed (indicate zero) during the Jog function.
3. The current transformers do not work with Jog currents because they saturate due to the low Jog frequencies.
4. In order to use high Jog levels, the SSW must be oversized.
5. To perform correct current measurements during the Jog, it is necessary to use Hall effect current transformers.

C7.4 Braking

These methods are used where there is the need to reduce the motor stopping time.

C7.4 Braking

C7.4.1 Mode

Range:	0 ... 3	Default: 0
Properties:	Stopped	

Description:

It enables and selects the braking type that will be applied to the motor.

Indication	Description
0 = Inactive	No braking.
1 = Reverse	Reverse braking via input contactors.
2 = Optimal	Pulsed DC braking applied to the motor.
3 = DC	Continuous DC braking applied to the motor.

The SSW has three different braking methods.

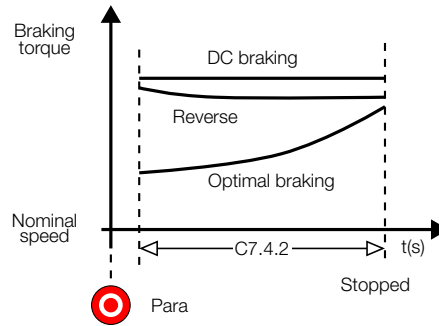

Figure 11.31: Braking torque.

Reverse Braking:

This is an efficient braking method, capable of stopping high inertia loads.

The motor will stop due to an AV voltage level, opposite to the rotation direction, applied to the motor until reaching approximately 20% of its rated speed, when the optimal braking is activated to stop the motor. C7.4.3 programs the AC voltage level and the optimal braking level, which will be applied to the motor.

Two contactors are necessary to invert the motor rotation direction.

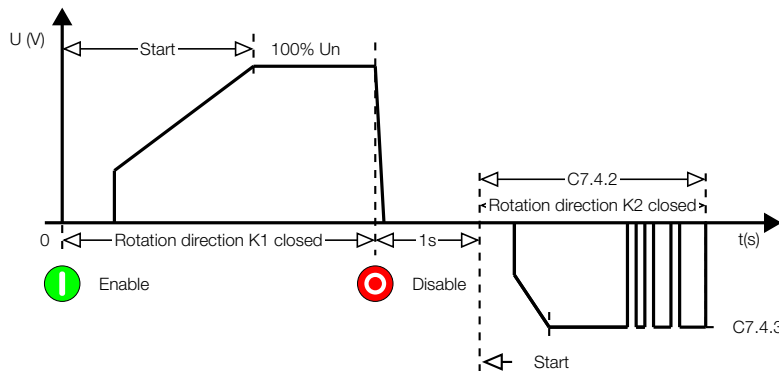

Figure 11.32: Reverse braking.



NOTE!

1. Both contactors must be of the same model and they must withstand the motor starting current. For safety reasons, the auxiliary contacts must be used to prevent the two contactors to close simultaneously.
2. Use a digital input programmed for General Enable to stop the motor without the braking.
3. For safety reasons, use a digital input programmed for Braking Off in order to make it possible to use a motor stopping sensor, which disables the motor preventing it from rotating in the opposite direction.
4. The SSW does not protect the motor during the braking process without using temperature sensors together with the PT100 board.

Optimal Braking:

This is an efficient method to stop medium inertia loads.

A DC voltage is applied only as long as it is able to produce a braking effect. There is no need for contactors.

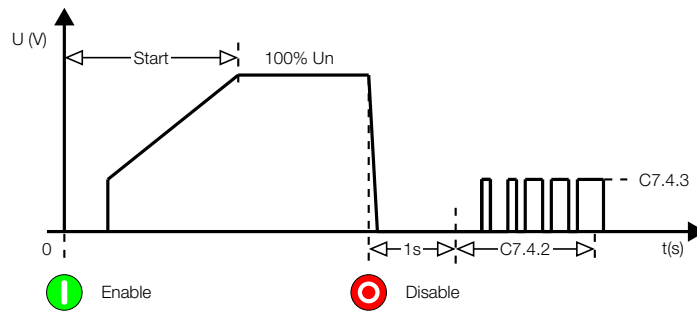

Figure 11.33: Optimal braking.



NOTE!

1. Use a digital input programmed for General Enable to stop the motor without the braking.
2. For safety reasons, use a digital input programmed for Braking Off in order to make it possible to use a motor stopping sensor, which disables the motor immediately.
3. Optimal braking is not recommended for two and eight pole motors.
4. The SSW does not protect the motor during the braking process without using temperature sensors together with the PT100 board.

DC Braking:

This is an old and efficient method, able to stop high inertia loads rapidly.

A DC current is applied continuously to the motor until it stops. The current needed to stop the motor is high and is applied continuously.

A contactor to short-circuit the U and V output phases is necessary.

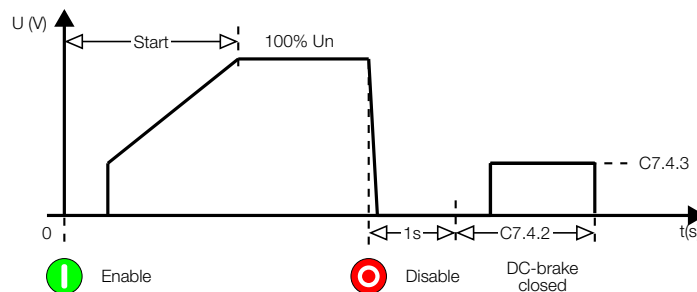

Figure 11.34: DC Braking



NOTE!

1. Use a digital input programmed for General Enable to stop the motor without the braking.
2. Use a digital input programmed for Braking Off in order to make it possible to use a motor stopping sensor and disable the braking immediately.
3. The SSW does not protect the motor during the braking process without using temperature sensors together with the PT100 board.

C7.4 Braking

C7.4.2 Time

Range: 1 ... 299 s

Default: 10

Properties: Stopped

Description:

Adjusts the maximum time that the braking is applied.

WARNING!

1. This is the main protection of all of the braking methods. Program it according to the application needs, if the motor and the SSW are able to withstand it.
2. The parameters status: S1.1, S1.5 e S1.7 are zeroed (indicate zero) during the optimal braking and the DC braking.
3. The current transformers do not work with DC due to their saturation.
4. The SSW does not protect the motor during the braking process without using temperature sensors together with the PT100 board.

C7.4 Braking
C7.4.3 Level

Range:	30 ... 70 %	Default: 30
Properties:	Stopped	

Description:

Adjusts the DC voltage level that will be applied to the motor.

This level is based in the AC voltage that will be converter into DC. This parameter does also adjust the level of the AC voltage that will be applied during the reverse braking.

WARNING!

1. Be careful with this braking voltage level. Program it according to the application needs, if the motor and the SSW are able to withstand it.
2. Begin with a low value and increase it until reaching the necessary level.
3. The current transformers do not work with DC due to their saturation.
4. The SSW does not protect the motor during the braking process without using temperature sensors together with the PT100 board.
5. In order to use high braking levels, the SSW must be oversized.
6. To perform correct current measurements during the braking, it is necessary to use Hall effect current transformers.

C7.4 Braking
C7.4.4 End

Range:	0 ... 1	Default: 0
Properties:	Stopped	

Description:

This functions makes possible the motor standstill detection.

Indication	Description
0 = Inactive	No detection of motor standstill.
1 = Automatic	With automatic motor standstill detection.

NOTE!

1. This detection does not work with two pole or eight pole motors.
2. The motor standstill detection may vary according to the motor temperature.
3. Always use the maximum braking time, C7.4.2, as the main protection.

C8 COMMUNICATION

To change information via communication network, the SSW has several standard protocols.

The following necessary accessories and protocols are available:

Protocol	Accessory
CANopen	SSW900-CAN-W
DeviceNet	SSW900-CDN-N, SSW900-CAN-W
EtherNet/IP	SSW900-CETH-IP-N
Modbus RTU	SSW900-CRS485-W
Modbus TCP	SSW900-CMB-TCP-N
Profibus DP	SSW900-CPDP-N
PROFINET IO	SSW900-CPN-IO-N

For further details regarding the SSW configuration to operate these protocols, refer to the SSW Communication Manual.

C8.1 I/O Data

Configure network data exchange area.

Use this for cyclic communication over SSW900-CAN-W module (DeviceNet), SSW900-CPDP-N, SSW900-CDN-N, SSW900-CETH-IP-N and SSW900-CPN-IO-N. For SSW900-CRS485-W using Modbus RTU protocol or SSW900-CMB-TCP-N module, a contiguous area of holding registers (@1500-@1549 and @1600-@1619) can be accessed using standard Modbus functions.

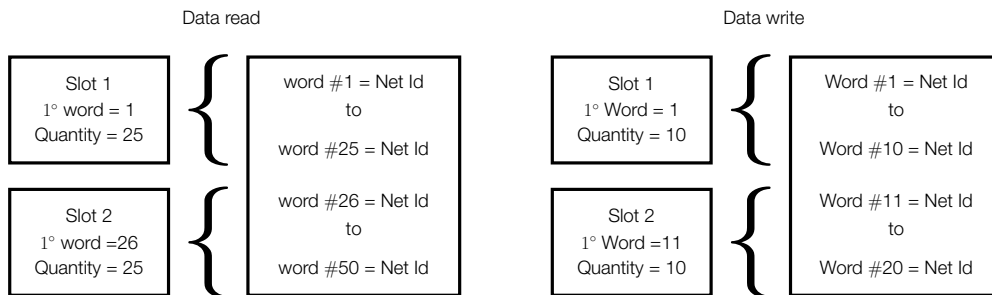

Figure 11.35: Example of data setting

C8.1.1 Data Read

Configure a set of 16 bit parameters to read over the network.

C8.1.1 Data Read		
C8.1.1.1 Slot 1 1st Word		
Range:	1 ... 50	Default: 1
Properties:	Stopped	

Description:

It sets the index of the first programmable read word for data communication (inputs for master).

C8.1.1 Data Read		
C8.1.1.2 Slot 1 Quantity		
Range:	1 ... 50	Default: 1
Properties:	Stopped	

Description:

It sets the number of read words for data communication (inputs for master), from the first word on.

C8.1.1 Data Read
C8.1.1.3 Slot 2 1st Word

Range:	1 ... 50	Default: 26
Properties:	Stopped	

Description:

It sets the index of the first programmable read word for data communication (inputs for master).

C8.1.1 Data Read
C8.1.1.4 Slot 2 Quantity

Range:	1 ... 50	Default: 1
Properties:	Stopped	

Description:

It set the number of read words for data communication (inputs for master), from the first word on.

C8.1.1 Data Read
C8.1.1.5 Word #1

C8.1.1.5 to C8.1.1.54

C8.1.1 Data Read
C8.1.1.54 Word #50

Range:	0 ... 65535	Default: 0
Properties:	Stopped	

Description:

Select the net address of other parameter, which content will be available as reading data for fieldbus interfaces (inputs: sent to master).

The data size of the referenced parameter must be considered. If data size is bigger than 16 bits, the next data read word configuration must be set to the same net address.

C8.1.2 Data Write

Configure a set of 16 bit parameters to write over the network.

C8.1.2 Data Write
C8.1.2.1 Slot 1 1st Word

Range:	1 ... 20	Default: 1
Properties:	Stopped	

Description:

It sets the index of the first programmable write word for data communication (outputs for master).

C8.1.2 Data Write
C8.1.2.2 Slot 1 Quantity

Range:	1 ... 20	Default: 1
Properties:	Stopped	

Description:

It sets the number of write words for data communication (outputs for master), from the first word on.

C8.1.2 Data Write
C8.1.2.3 Slot 2 1st Word

Range:	1 ... 20	Default: 11
Properties:	Stopped	

Description:

It sets the index of the first programmable write word for data communication (outputs for master).

C8.1.2 Data Write
C8.1.2.4 Slot 2 Quantity

Range: 1 ... 20

Default: 1

Properties: Stopped

Description:

It sets the number of write words for data communication (outputs for master), from the first word on.

C8.1.2 Data Write
C8.1.2.5 Update Delay

Range: 0.0 ... 999.9 s

Default: 0.0

Properties:

Description:

Whenever there is a transition from offline (without cyclic data) to online (with cyclic write data), the data received via communication networks (write words) is ignored during this programmed time, remaining in the state it was before the beginning of the reception.

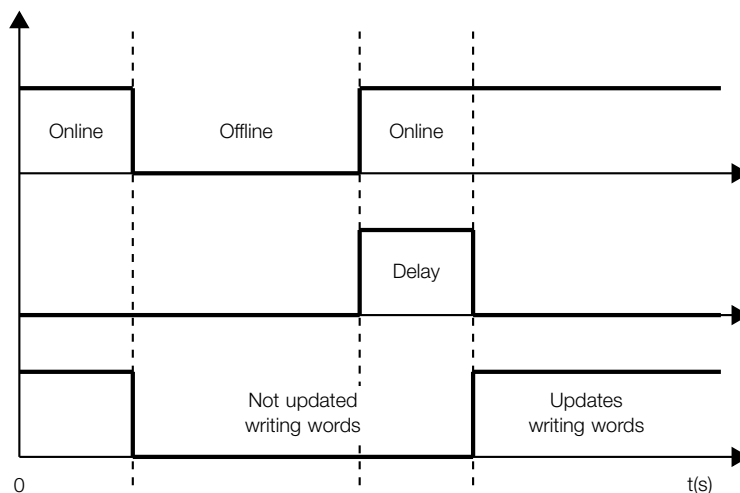

Figure 11.36: Delay in the update of the I/O words

C8.1.2 Data Write
C8.1.2.6 Word #1

C8.1.2.6 to C8.1.2.25

C8.1.2 Data Write
C8.1.2.25 Word #20

Range: 0 ... 65535

Default: 0

Properties: Stopped

Description:

Select the net address of other parameter, which content will be available as writing data for fieldbus interfaces (outputs: received from master).

The data size of the referenced parameter must be considered. If data size is bigger than 16 bits, the next data write word configuration must be set to the same net address.

C8.2 RS485 Serial

Configuration for RS485 accessory, and the protocols using this interface.

For a detailed description, refer to the SSW900 Modbus-RTU User's Manual, supplied in electronic format.

C8.2 RS485 Serial		
C8.2.1 Serial Protocol		
Range:	0 ... 2	Default: 2
Properties:		

Description:

Select the desired protocol for the serial interface.

Indication	Description
0 ... 1 = Reserved	Not available.
2 = Modbus RTU	Modbus RTU serial protocol.

C8.2 RS485 Serial		
C8.2.2 Address		
Range:	1 ... 247	Default: 1
Properties:		

Description:

Select the address used for the serial communication.

It is necessary that each device in the network has an address different from all the others.

C8.2 RS485 Serial		
C8.2.3 Baud Rate		
Range:	0 ... 3	Default: 1
Properties:		

Description:

Select the baud rate for the serial communication interface, in bits per second. This configuration must be identical for all the devices connected to the network.

Indication	Description
0 = 9600 bits/s	Bit rate per second.
1 = 19200 bits/s	Bit rate per second.
2 = 38400 bits/s	Bit rate per second.
3 = 57600 bits/s	Bit rate per second.

C8.2 RS485 Serial		
C8.2.4 Bytes Config.		
Range:	0 ... 5	Default: 1
Properties:		

Description:

Select the number of data bits, parity and stop bits of the serial interface bytes. This configuration must be identical for all the devices connected to the network.

Indication	Description
0 = 8 bits, no, 1	8 bits, without parity, 1 stop bit.
1 = 8 bits, even,1	8 bits, with even parity, 1 stop bit.
2 = 8 bits, odd, 1	8 bits, with odd parity, 1 stop bit.
3 = 8 bits, no, 2	8 bits, without parity, 2 stop bit.
4 = 8 bits, even,2	8 bits, with even parity, 2 stop bit.
5 = 8 bits, odd, 2	8 bits, with odd parity, 2 stop bit.

C8.2.5 Timeout

Protection against fault in the RS485 communication.

In case the product does not receive valid telegrams for a period longer than the setting, a communication error will be indicated, alarm A128 or fault F128 will be displayed on the HMI, depending on the programming of C8.2.5.1, and the action programmed in C8.2.5.2 will be executed.

Time will start counting from the first valid telegram received.

C8.2.5 Timeout
C8.2.5.1 Mode

Range: 0 ... 2 **Default:** 0
Properties:

Description:

It allows configuring the protection tripping mode for RS485 communication timeout.

Indication	Description
0 = Inactive	No tripping.
1 = Fault F128	Trips as fault. Disables the motor.
2 = Alarm A128	Trips as alarm. Action described in C8.2.5.2.

C8.2.5 Timeout
C8.2.5.2 Alarm Action

Range: 0 ... 4 **Default:** 3
Properties:

Description:

Action for the RS485 communication timeout alarm.

The actions described in this parameter are executed through the writing of the respective bits in the control word of the SLOT to which the RS485 is connected. Thus, for the commands to be effective, the equipment must be programmed to be controlled by the network interface used. This programming is done through menu C3.

Indication	Description
0 = Indicates Only	No action is taken; the equipment remains in the current state.
1 = Ramp Stop	The stop by ramp command is executed, and the motor stops according to the programmed deceleration ramp.
2 = General Disable	The equipment is general disabled, and the motor stops by inertia.
3 = Change to LOC	The equipment is commanded to local mode.
4 = Change to REM	The equipment is commanded to remote mode.

NOTE!

The alarm action will only have a function if the timeout tripping mode C8.2.5.1 is programmed for Alarm A128.

C8.2.5 Timeout
C8.2.5.3 Timeout

Range: 0.0 ... 999.9 s **Default:** 0.0
Properties:

Description:

Maximum time without communication.

C8.3 Anybus-CC

Configuration for the Anybus-CC communication and protocols that use this interface.

For a detailed description, refer to the SSW900 Anybus-CC User's Manual specific for the desired protocol, supplied in electronic format.

C8.3 Anybus-CC

C8.3.1 Update Configuration

Range:	0 ... 1	Default: 0
Properties:	Stopped	

Description:

It allows forcing a reinitialization of the Anybus-CC communication module for the configurations done in the parameters of menus C8.1 and C8.3 to be applied.

The reinitialization implies communication loss. After the process is completed, this parameter automatically goes back to Regular Operation.

Indication	Description
0 = Normal Operation	No action.
1 = Update configuration	Reinitializes the Anybus module.

C8.3 Anybus-CC

C8.3.2 Address

Range:	0 ... 255	Default: 63
Properties:		

Description:

Select the address used for the anybus module in the network.

It is necessary that each device in the network has an address different from all the others. This configuration is used for the Anybus-CC Profibus and DeviceNet modules only. For DeviceNet the range is 0 to 63 and for Profibus it is 1 to 126.



NOTE!

After changing this configuration, for the modification to be effective, the equipment must be turned off and then turned on again, or the configurations must be updated through C8.3.1.

C8.3 Anybus-CC

C8.3.3 Baud Rate

Range:	0 ... 3	Default: 3
Properties:		

Description:

Select the baud rate for the Anybus module, in bits per second.

This configuration must be identical for all the devices connected to the network. This configuration is used for the Anybus-CC DeviceNet module only.

Indication	Description
0 = 125 kbps	Bit rate per second.
1 = 250 kbps	Bit rate per second.
2 = 500 kbps	Bit rate per second.
3 = Autobaud	Automatic bit rate.

NOTE!

After changing this configuration, for the modification to be effective, the equipment must be turned off and then turned on again, or the configurations must be updated through C8.3.1.

C8.3 Anybus-CC
C8.3.4 IP Address Configuration
Range: 0 ... 2

Default: 1

Properties:
Description:

It allows to choose how to set the IP address for the modules Anybus-CC EtherNet/IP, Modbus TCP and PROFINET IO.

Indication	Description
0 = Parameters	The programming of the IP address, configurations of the subnet mask and gateway must be done through parameters C8.3.5, C8.3.6 and C8.3.7.
1 = DHCP	Enables the DHCP function. The IP address and other network configurations are received from a DHCP server via network.
2 = DCP	The IP address and other network configurations are received via DCP (PROFINET IO).

NOTE!

After changing this configuration, for the modification to be effective, the equipment must be turned off and then turned on again, or the configurations must be updated through C8.3.1.

C8.3 Anybus-CC
C8.3.5 IP Address
Range: 0.0.0.0 ... 255.255.255.255

Default: 192.168.0.10

Properties:
Description:

It allows programming the IP address of the module Anybus-CC EtherNet/IP, Modbus TCP or PROFINET IO. It is only effective if C8.3.4 = Parameters.

NOTE!

After changing this configuration, for the modification to be effective, the equipment must be turned off and then turned on again, or the configurations must be updated through C8.3.1.

C8.3 Anybus-CC
C8.3.6 CIDR
Range: 0 ... 31

Default: 24

Properties:
Description:

It allows programming the subnet mask used by the module Anybus-CC EtherNet/IP, Modbus TCP or PROFINET IO. It is only effective if C8.3.4 = Parameters.

Indication	Description
0 = Reserved	
1 = 128.0.0.0	Subnet mask.
2 = 192.0.0.0	Subnet mask.
3 = 224.0.0.0	Subnet mask.
4 = 240.0.0.0	Subnet mask.
5 = 248.0.0.0	Subnet mask.
6 = 252.0.0.0	Subnet mask.
7 = 254.0.0.0	Subnet mask.
8 = 255.0.0.0	Subnet mask.
9 = 255.128.0.0	Subnet mask.
10 = 255.192.0.0	Subnet mask.
11 = 255.224.0.0	Subnet mask.
12 = 255.240.0.0	Subnet mask.
13 = 255.248.0.0	Subnet mask.
14 = 255.252.0.0	Subnet mask.
15 = 255.254.0.0	Subnet mask.
16 = 255.255.0.0	Subnet mask.
17 = 255.255.128.0	Subnet mask.
18 = 255.255.192.0	Subnet mask.
19 = 255.255.224.0	Subnet mask.
20 = 255.255.240.0	Subnet mask.
21 = 255.255.248.0	Subnet mask.
22 = 255.255.252.0	Subnet mask.
23 = 255.255.254.0	Subnet mask.
24 = 255.255.255.0	Subnet mask. Factory setting.
25 = 255.255.255.128	Subnet mask.
26 = 255.255.255.192	Subnet mask.
27 = 255.255.255.224	Subnet mask.
28 = 255.255.255.240	Subnet mask.
29 = 255.255.255.248	Subnet mask.
30 = 255.255.255.252	Subnet mask.
31 = 255.255.255.254	Subnet mask.

NOTE!

After changing this configuration, for the modification to be effective, the equipment must be turned off and then turned on again, or the configurations must be updated through C8.3.1.

C8.3 Anybus-CC
C8.3.7 Gateway

Range: 0.0.0.0 ... 255.255.255.255

Default: 0.0.0.0

Properties:

Description:

It allows programming the IP address of the standard gateway used by the module Anybus-CC EtherNet/IP, Modbus TCP or PROFINET IO. It is only effective if C8.3.4 = Parameters.

NOTE!

After changing this configuration, for the modification to be effective, the equipment must be turned off and then turned on again, or the configurations must be updated through C8.3.1.

C8.3 Anybus-CC
C8.3.8 Station Name Suffix

Range: 0 ... 254

Default: 0

Properties:

Description:

Allows defining the PROFINET IO Station Name suffix. The Station Name has the format SSW900-xxx, where xxx is the number set in this parameter. Example: C8.3.8 = 42 – Station Name = SSW900-042.

The value 0 (zero) disables the assignment of the Station Name, allowing the Station Name to be assigned via DCP.

C8.3.9 Modbus TCP Timeout

Protection against fault in the Modbus TCP communication.

In case the product does not receive valid Modbus TCP telegrams for writing in the I/O data area (C8.1) or in the SLOT command word a period longer than the setting, a communication error will be indicated, alarm A131 or fault F131 will be displayed on the HMI, depending on the programming of C8.3.8.1, and the action programmed in C8.3.8.2 will be executed.

Time will start counting from the first valid telegram received. This error is only generated for the Anybus-CC Modbus TCP module.

C8.3.9 Modbus TCP Timeout
C8.3.9.1 Mode

Range: 0 ... 2

Default: 0

Properties:

Description:

It allows configuring the protection tripping mode for Modbus TCP communication timeout.

Indication	Description
0 = Inactive	No tripping.
1 = Fault F131	Trips as fault. Disables the motor.
2 = Alarm A131	Trips as alarm. Action described in C8.3.8.2.

C8.3.9 Modbus TCP Timeout
C8.3.9.2 Alarm Action

Range: 0 ... 4

Default: 3

Properties:

Description:

Action for the Modbus TCP communication timeout alarm.

The actions described in this parameter are executed through the writing of the respective bits in the control word of the SLOT to which the Anybus-CC Modbus TCP accessory is connected. Thus, for the commands to be effective, the equipment must be programmed to be controlled by the network interface used. This programming is done through menu C3.

Indication	Description
0 = Indicates Only	No action is taken; the equipment remains in the current state.
1 = Ramp Stop	The stop by ramp command is executed, and the motor stops according to the programmed deceleration ramp.
2 = General Disable	The equipment is general disabled, and the motor stops by inertia.
3 = Change to LOC	The equipment is commanded to local mode.
4 = Change to REM	The equipment is commanded to remote mode.

NOTE!

The alarm action will only have a function if the timeout tripping mode C8.3.8.1 is programmed for Alarm A131.

C8.3.9 Modbus TCP Timeout
C8.3.9.3 Modbus TCP Timeout
Range: 0.0 ... 999.9 s

Default: 0.0

Properties:
Description:

Maximum time without communication.

C8.3.10 Off Line Error

Protection against interruption in the communication with the network master.

If for some reason there is an interruption in the communication between the product and the network master, a communication error will be indicated, alarm A129 or fault F129 will be shown on the HMI, depending on the programming of C8.3.9.1, and the action programmed in C8.3.9.2 will be executed.

It only occurs after the equipment is online. This error is generated for the modules Anybus-CC DeviceNet, EtherNet/IP, Profibus DP and PROFINET IO.

C8.3.10 Off Line Error
C8.3.10.1 Mode
Range: 0 ... 2

Default: 0

Properties:
Description:

It allows configuring the tripping mode of the protection against interruption in the communication with the network master.

Indication	Description
0 = Inactive	No tripping.
1 = Fault F129	Trips as fault. Disables the motor.
2 = Alarm A129	Trips as alarm. Action described in C8.3.10.2.

C8.3.10 Off Line Error
C8.3.10.2 Alarm Action
Range: 0 ... 4

Default: 3

Properties:
Description:

Action for the Anybus-CC Offline communication alarm.

The actions described in this parameter are executed through the writing of the respective bits in the control word of the SLOT to which the accessory Anybus-CC DeviceNet, EtherNet/IP, Profibus DP or PROFINET IO is connected. Thus, for the commands to be effective, the equipment must be programmed to be controlled by the network interface used. This programming is done through menu C3.

Indication	Description
0 = Indicates Only	No action is taken; the equipment remains in the current state.
1 = Ramp Stop	The stop by ramp command is executed, and the motor stops according to the programmed deceleration ramp.
2 = General Disable	The equipment is general disabled, and the motor stops by inertia.
3 = Change to LOC	The equipment is commanded to local mode.
4 = Change to REM	The equipment is commanded to remote mode.

NOTE!

The alarm action will only have a function if the error tripping mode C8.3.9.1 is programmed for Alarm A129.

C8.4 CANopen/DeviceNet

Configuration for the SSW900-CAN-W communication accessory and protocols that use this interface.

C8.4 CANopen/DeviceNet

C8.4.1 Protocol

Range: 0 ... 2 **Default:** 2
Properties:

Description:

It allows selecting the desired protocol for the CAN interface.

Indication	Description
0 = Disabled	Disable CAN interface.
1 = CANopen	Enable CAN interface with CANopen protocol.
2 = DeviceNet	Enable CAN interface with DeviceNet protocol.

C8.4 CANopen/DeviceNet

C8.4.2 Address

Range: 0 ... 127 **Default:** 63
Properties:

Description:

It allows programming the address used for the CAN communication. It is necessary that each element of the network has an address different from the others. The valid addresses for this parameter depend on the protocol programmed in P0700:

- P0700 = 1 (CANopen): valid addresses: 1 to 127.
- P0700 = 2 (DeviceNet): valid addresses: 0 to 63.



NOTE!

After changing this configuration, for the modification to be effective, the change takes effect only if the CAN interface is not exchanging cyclic data with the network.

C8.4 CANopen/DeviceNet

C8.4.3 Baud Rate

Range: 0 ... 8 **Default:** 0
Properties:

Description:

It allows programming the desired baud rate for the CAN interface, in bits per second. This rate must be the same for all the devices connected to the network. The supported baud rates for the device depend on the protocol programmed in the parameter C8.4.1:

- C8.4.1 = 1 (CANopen): It is possible to use any rate specified in this parameter, but it does not have the automatic baud rate detection function – autobaud.
- C8.4.1 = 2 (DeviceNet): only the 500, 250 and 125 Kbit/s rates are supported. Other options will enable the automatic baud rate detection function – autobaud.

After a successful detection, the baud rate parameter (C8.4.3) changes automatically to the detected rate. In order to execute the autobaud function again, it is necessary to change the parameter C8.4.3 to one of the 'Autobaud' options.

Indication	Description
0 = 1 Mbps/Auto	CAN baud rate (automatic detection for DeviceNet).
1 = Reserved	Reserved
2 = 500 Kbps	CAN baud rate.
3 = 250 Kbps	CAN baud rate.
4 = 125 Kbps	CAN baud rate.
5 = 100 Kbps/Auto	CAN baud rate (automatic detection for DeviceNet).
6 = 50 Kbps/Auto	CAN baud rate (automatic detection for DeviceNet).
7 = 20 Kbps/Auto	CAN baud rate (automatic detection for DeviceNet).
8 = 10 Kbps/Auto	CAN baud rate (automatic detection for DeviceNet).

NOTE!

After changing this configuration, for the modification to be effective, the change takes effect only if the CAN interface is not exchanging cyclic data with the network.

C8.4 CANopen/DeviceNet
C8.4.4 Bus Off Reset
Range: 0 ... 1

Default: 1

Properties:
Description:

It allows programming the inverter behavior when detecting a bus off error at the CAN interface.

Indication	Description
0 = Manual	If bus off occurs, the A134/F134 alarm will be indicated on the HMI and the communication will be disabled. In case of alarm, the action programmed in parameter C8.4.5.2 will be executed. In order that the inverter communicates again through the CAN interface, it will be necessary to disable and enable the interface, or reinitiate the device.
1 = Automatic	If bus off occurs, the communication will be reinitiated automatically and the error will be ignored. In this case the alarm will not be indicated on the HMI and the inverter will not execute the action programmed in C8.4.5.2.

C8.4.5 CAN Error

Protection against interruption in the CAN communication.

If for some reason there is an interruption in the CAN communication, a communication error will be indicated, alarm A133...A137 or fault F133...F137 will be shown on the HMI, depending on the programming of C8.4.5.1, and the action programmed in C8.4.5.2 will be executed.

It only occurs after the equipment is online. This error is only generated for the SSW900-CAN-W module.

C8.4.5 CAN Error
C8.4.5.1 Mode
Range: 0 ... 2

Default: 0

Properties:
Description:

It allows configuring the tripping mode of the protection against interruption in the CAN communication.

Indication	Description
0 = Inactive	No tripping.
1 = Fault	Trips as fault. Disables the motor.
2 = Alarm	Trips as alarm. Action described in C8.4.5.2.

C8.4.5 CAN Error
C8.4.5.2 Alarm Action
Range: 0 ... 4

Default: 0

Properties:
Description:

Action for the CAN communication interruption alarm.

The actions described in this parameter are executed through the writing of the respective bits in the control word of the SLOT to which the accessory SSW900-CAN-W is connected. Thus, for the commands to be effective, the equipment must be programmed to be controlled by the network interface used. This programming is done through menu C3.

Indication	Description
0 = Indicates Only	No action is taken; the equipment remains in the current state.
1 = Ramp Stop	The stop by ramp command is executed, and the motor stops according to the programmed deceleration ramp.
2 = General Disable	The equipment is general disabled, and the motor stops by inertia.
3 = Change to LOC	The equipment is commanded to local mode.
4 = Change to REM	The equipment is commanded to remote mode.

NOTE!

The alarm action will only have a function if the error tripping mode C8.4.5.1 is programmed for Alarm.

C8.6 Bluetooth

The following configurations are available for products that have HMI interface with integrated bluetooth technology.

In order to use this product with another bluetooth enabled device, the two device need to be paired.

C8.6 Bluetooth
C8.6.1 Mode
Range: 0 ... 1

Default: 0

Properties:
Description:

The bluetooth setting is disabled by default. This setting must be enabled in order to use bluetooth wireless interface.

Indication	Description
0 = Off	Inactive.
1 = On	Active.

C8.6 Bluetooth
C8.6.2 PIN
Default: 123456

Properties:
Description:

Before you use the product with another bluetooth enabled device for the first time, pair it using the six digit PIN configured in this parameter.

The PIN must have 6 digits from 0 to 9.

C8.6 Bluetooth
C8.6.3 Device Name
Default: SSW9x

Properties:
Description:

You can configure the bluetooth device name.

By default the bluetooth name of the product is SSW9x plus product serial number (e. g. SSW9x0123456789).

The device name must have from 1 to 15 alphanumeric digits.

C9 SSW900

This group contains the necessary configurations for the correct operation of the SSW.

C9.1 Nominal Data

Characteristics that identify the SSW model.

C9.1 Nominal Data
C9.1.1 Current
Range: 0 ... 21

Default: 0

Properties: Stopped

Description:

It programs the SSW rated current.

Indication	Description
0 = 10 A	10A current model. Frame A.
1 = 17 A	17A current model. Frame A.
2 = 24 A	24A current model. Frame A.
3 = 30 A	30A. current model. Frame A.
4 = 45 A	45A current model. Frame B.
5 = 61 A	61A current model. Frame B.
6 = 85 A	85A current model. Frame B.
7 = 105 A	105A current model. Frame B.
8 = 130 A	130A current model. Frame C.
9 = 171 A	171A current model. Frame C.
10 = 200 A	200A current model. Frame C.
11 = 255 A	255A current model. Frame D.
12 = 312 A	312A current model. Frame D.
13 = 365 A	365A current model. Frame D.
14 = 412 A	412A current model. Frame D.
15 = 480 A	480A current model. Frame E.
16 = 604 A	604A current model. Frame E.
17 = 670 A	670A current model. Frame E.
18 = 820 A	820A current model. Frame F.
19 = 950 A	950A current model. Frame F.
20 = 1100 A	1100A current model. Frame G.
21 = 1400 A	1400A current model. Frame G.

NOTE!

The programmed rated current must be exactly the one indicated on the SSW identification label.

C9.2 Types of Connections

It configures the SSW to operate according to the connection types made in the electrical installation.

C9.2 Types of Connections

C9.2.1 Delta Inside

Range:	0 ... 1	Default: 0
Properties:	Stopped	

Description:

It allows enabling the SSW operation within the Motor Delta connection.

Indication	Description
0 = Off	Inactive.
1 = On	Active.

SSW offers two operation modes: Standard Connection or Inside Delta Motor Connection.

When a **Standard Connection** (0=Inactive) is used, the motor is connected in series to the SSW through three cables.

When an **Inside Delta Connection** (1=Active) is used, the SSW is connected separately in each winding through six cables (see the user manual). In this type of connection, the current that flows through the SSW is only the current of the inside delta motor connection, in other words, 58% of the nominal motor current. This characteristic changes the relation between the SSW nominal currents and those of the motor. In this connection, the SSW can be used with its nominal current dimensioned in the following way:

- 1.5 times the nominal motor current during start;
- 1.73 times the nominal motor current during full voltage.

During the start, the relation is lower due to the characteristics that are common to this type of connection (inside delta) the Thyristors of the SSW need to conduct the same current for a lower time period, increasing with this the losses in the Thyristor during the start.

The Inside Delta Motor Connection requires double wiring, but for short distances, this will be a cheaper option for the SSW + motor + wiring set.



NOTE!

Do not start the motor with the wrong connection. If this parameter is incorrectly programmed, the SSW may be damaged.

C9.2 Types of Connections

C9.2.2 External Bypass

Range:	0 ... 1	Default: 0
Properties:	Stopped	

Description:

This function is enabled when the installation of an external bypass contactor is required that must be connected in parallel to the SSW.

Indication	Description
0 = Without	Without external bypass contactor.
1 = With	With external bypass contactor.

With the external bypass programmed in C9.2.2, the internal bypass will not enable.

The external bypass contactor is used:

- (1) For instance when a direct start is required in case of an emergency. The internal bypass contactors do not permit a direct start. These contactors can be enabled only after the motor start has been realized by the thyristors;
- (2) If the motor stalls frequently during bypass condition.

NOTE!

See the recommended setup at the user manual for more information.

NOTE!

In order to maintain the protections based on the current readings, it is necessary to use the external accessory for current measurement.

C9.3 Accessories Config.

It allows the use of a certain accessory.

If the accessory is not installed or is removed , the SSW will indicate a fault.

C9.3 Accessories Config.

C9.3.1 Slot 1

Range: 0 ... 8 **Default:** 0

Properties:

Description:

It configures the mandatory accessory for Slot 1.

Indication	Description
0 = Automatic	Automatic identification. It does not demand the use of a certain accessory.
1 = Anybus-CC	Anybus-CC communication accessory. SSW900-xxxxxx-N.
2 = RS-485	RS-485 communication accessory. SSW900-CRS485-W.
3 = PT100	Motor PT100 input accessory. SSW900-PT100-W.
4 = I/Os Exp.	Digital input and output expansion accessories. SSW900-EIO-W.
5 = Profibus	Profibus-DP communication accessory. SSW900-CPDP-W.
6 = CAN	DeviceNet or CANopen communication accessory. SSW900-CAN-W.
7 = Ethernet	Ethernet communication accessory. SSW900-CETH-W.
8 = External Current Acqu.	External Current Acquisition accessory. SSW900-ECA.

C9.3 Accessories Config.

C9.3.2 Slot 2

Range: 0 ... 8 **Default:** 0

Properties:

Description:

It configures the mandatory accessory for Slot 2.

Indication	Description
0 = Automatic	Automatic identification. It does not demand the use of a certain accessory.
1 = Anybus-CC	Anybus-CC communication accessory. SSW900-xxxxxx-N.
2 = RS-485	RS-485 communication accessory. SSW900-CRS485-W.
3 = PT100	Motor PT100 input accessory. SSW900-PT100-W.
4 = I/Os Exp.	Digital input and output expansion accessories. SSW900-EIO-W.
5 = Profibus	Profibus-DP communication accessory. SSW900-CPDP-W.
6 = CAN	DeviceNet or CANopen communication accessory. SSW900-CAN-W.
7 = Ethernet	Ethernet communication accessory. SSW900-CETH-W.
8 = External Current Acqu.	External Current Acquisition accessory. SSW900-ECA.

NOTE!

The accessories can be installed in any slot, but they cannot be duplicated. Only one of a kind can be used.

NOTE!

Accessories can not be installed or removed with the SSW energized.

C9.4 Fan Configuration

It allows configuring the fan operation.

C9.4 Fan Configuration

C9.4.1 Mode

Range: 0 ... 2

Default: 2

Properties:

Description:

It defines the operation of the fan control.

Indication	Description
0 = Always Off	The fan remains constantly turned off.
1 = Always On	The fan remains constantly turned on.
2 = Controlled	The fan is controlled by the power heatsink temperature.

C10 LOAD / SAVE PARAMETERS

The SSW BACKUP functions allow changing, saving or loading the content of the configurations and/or diagnostics.

C10.1 Load / Save User

It allows saving the content of the SSW current configurations in a specific memory or overwriting the current configurations with the content of this memory.

C10.1 Load / Save User

C10.1.1 Mode

Range: 0 ... 6

Default: 0

Properties: Stopped

Description:

It selects what to load or save on the SSW configurations.

Indication	Description
0 = Not Used	Not Used: no action.
1 = Load User 1	Loads the SSW configurations with the content of user's memory 1.
2 = Load User 2	Loads the SSW configurations with the content of user's memory 2.
3 = Reserved	Not used. Do not use it.
4 = Save User 1	Saves the content of the SSW current configurations to user's memory 1.
5 = Save User 2	Saves the content of the SSW current configurations to user's memory 2.
6 = Reserved	Not used. Do not use it.

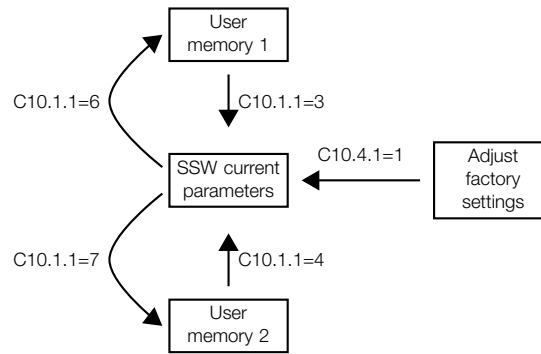

Figure 11.37: Saving and loading the configurations.

To load the configurations of User 1, User 2 to the SSW, these areas must be previously saved.

The operation of loading one of those memories can also be done via digital inputs (Dix). Refer to Chapter C4.1.

C10.2 Copy Function HMI

The Copy HMI function is used to transfer the content of the configurations from one SSW to another (or others).

C10.2 Copy Function HMI

C10.2.1 Mode

Range: 0 ... 2 **Default:** 0

Properties: Stopped

Description:

It selects the source and destination for the Copy HMI function.

Indication	Description
0 = Off	Not Used.
1 = SSW -> HMI	Saves the content of the configurations of the SSW to the HMI memory.
2 = HMI -> SSW	Loads the SSW configurations with the content of the HMI memory.

It is not necessary that SSWs have the same software version. If copying between SSWs with different software versions, nonexistent or incompatible parameters will not be copied.



NOTE!

The Copy function HMI does not copy the user memories 1 and 2.

To copy the configurations of one SSW to another, you must proceed as follows:

1. Connect the HMI to the SSW from which you want to copy the parameters (SSW A);
2. Set C10.2.1 = 1 (SSW -> HMI) to transfer the configurations from the SSW A to the HMI;
3. Press Enter. C10.2.1 automatically returns to 0 (Inactive), when the transfer is completed;
4. Disconnect the HMI from the SSW;
5. Connect this HMI to the SSW to which you want to transfer the configurations (SSW B);
6. Set C10.2.1 = 2 (HMI -> SSW) to transfer the content from the HMI non-volatile memory (containing the configurations of SSW A) to SSW B;
7. Press Enter. C10.2.1 returns to 0 when the transfer of the configurations is completed. From this moment, SSWs A and B will have the same configuration content.



Figure 11.38: Copy configurations of "SSW A" to "SSW B".



NOTE!

While the HMI is performing the reading or writing procedure, it is not possible to operate it.

C10.3 Erase Diagnostics

It allows erasing some diagnostics that were recorded.

C10.3 Erase Diagnostics

C10.3.1 Mode

Range:	0 ... 8	Default: 0
Properties:	Stopped	

Description:

It selects which diagnostics will be erased.

Indication	Description
0 ... 1 = Not Used	Not used.
2 = Fault	It erases the present fault and the fault history D1.
3 = Alarms	It erases the present alarm the the alarm history D2.
4 = Events	It erases the event history D3.
5 = Motor ON	It erases the records with the motor running D4. Minus D4.7.
6 = Temperaturas	It erases temperatures recorded D5.
7 = Hours Control	It erases the record of hours D6.2 e D6.3.
8 = Thermal Class Status	It erases the motor thermal image, which is a part of S4.2.1.

C10.4 Load Factory Default

It loads the factory settings, resets to the factory settings, loads the SSW configurations with the factory settings.

C10.4 Load Factory Default

C10.4.1 Mode

Range:	0 ... 1	Default: 0
Properties:	Stopped	

Description:

It loads the factory settings.

Indication	Description
0 = No	Not execute.
1 = Yes	Execute.

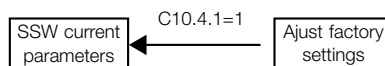

Figure 11.39: Load factory settings



NOTE!

In the Load Factory Settings, reset to factory settings, no change will be made to: Date, Time and Day of the Week C6.3, motor inside delta connection C9.2.1 and rated current of the SSW C9.1.

C10.5 Save Changed Param.

It manually saves all the configurations that have been changed since the electronics was de-energized.

C10.5 Save Changed Param.

C10.5.1 Mode

Range:	0 ... 1	Default: 0
Properties:	Stopped	

Description:

It saves the configurations changed.

Indication	Description
0 = No	Not execute.
1 = Yes	Execute.

In the SSW normal operation, all the configurations are changed on the volatile memory, RAM. When you de-energize the electronics, the configurations are saved in non-volatile FLASH memory. Thus, the configurations changed are automatically saved.

On the SSW with electronics power supply of +24Vdc, such automatic saving is not available. Therefore, whenever you make any changes in the configuration, you must save the changed parameters.



NOTE!

With electronics power supply of +24Vdc, the changed parameters must be saved manually.

C11 SOFTPLC

The SoftPLC function enables the SSW to execute PLC functions (Programmable Logic Controller).

The total memory size available for the SoftPLC ladder is 12k bytes.

For further details regarding the programming of those functions on the SSW, refer to the Help text of WPS (WEG Programming Suite) Software.

C11 SoftPLC

C11.1 Mode

Range:	0 ... 1	Default: 0
Properties:	Stopped	

Description:

It allows stopping or running an installed applicative. Therefore, the motor must be disabled.

Indication	Description
0 = Stop Program	Stops the application.
1 = Run Program	Runs the application.

C11 SoftPLC

C11.2 Action App. Not Running

Range: 0 ... 2

Default: 0

Properties:

Description:

It defines which action will be taken by the product in case the SoftPLC not running condition is detected, and it may generate alarm A708, fault F708 or neither of the previous actions, remaining inactive.

Indication	Description
0 = Inactive	No tripping.
1 = Alarm A708	Trips as alarm. It is just indicated.
2 = Fault F708	Trips as fault. Disables the motor.

C11.3 Parameter

They are usage parameters defined by the user via WPS software. The user can also configure those parameters.

C11.3 Parameter

C11.3.1 User #1

C11.3.1 to C11.3.50

C11.3 Parameter

C11.3.50 User #50

Range: -10000 ... 10000

Default: 0

Properties:

Description:

They consist of parameters with functions defined by the user by means of the WPS software. It is possible for the user to configure these parameters.



NOTE!

The user parameters set to writing (Configurations - C11.3.X) are always retentive. The user parameters set to Read Only (Status - S6.4.X) are not retentive.

12 A ASSISTANT

Assistant for oriented programming of some functions.

A1 ORIENTED START-UP

The function of the oriented start-up is to present a minimum programming sequence, necessary to put the motor in operation.

A1 Oriented Start-up		
A1.1 Mode		
Range:	0 ... 1	Default: 1
Properties:	Stopped	

Description:

Perform or leave the oriented start-up.

Indication	Description
0 = No	Not execute.
1 = Yes	Execute.

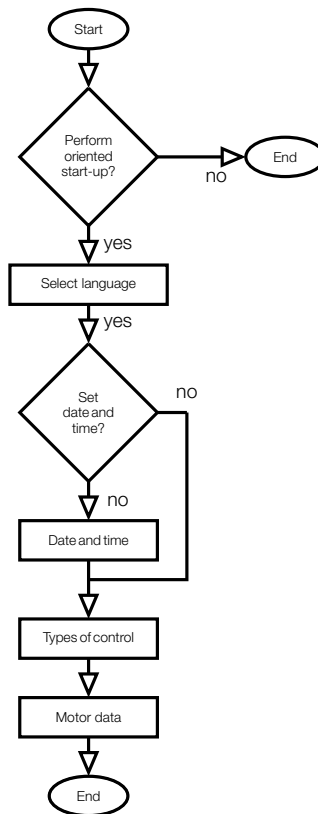

Figure 12.1: Oriented start-up programming sequence.

13 PROGRAMMING INFORMATION AND SUGGESTIONS

This chapter assists the user in adjusting and programming the types of starting control according to the application.

13.1 APPLICATIONS AND PROGRAMMING



WARNING!

Important hints and notes for each control type.



WARNING!

For the correct parameter setting, have the load data at hand and use the WEG Sizing Software - SDW - available at the WEG website (<http://www.weg.net>). If you are not able to use it, however, this chapter describes some practical principles.

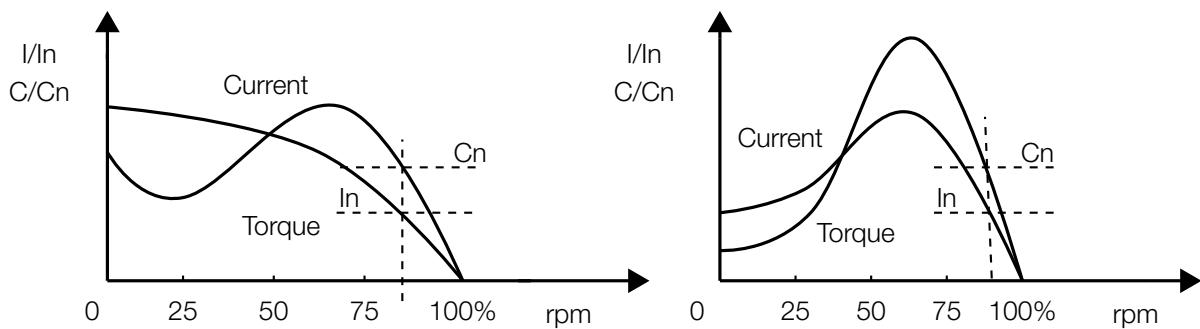

Figure 13.1: Torque and current characteristic curves of a direct on line start and of a Voltage Ramp start.

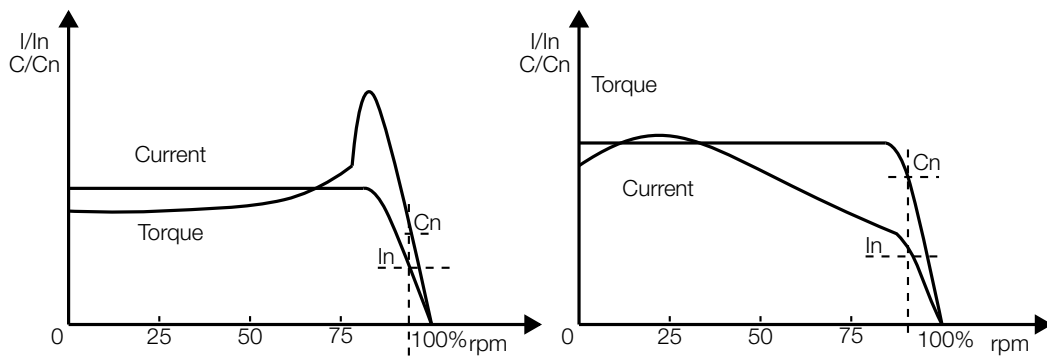

Figure 13.2: Torque and current characteristic curves of a Current Limit start and of a Torque Control start.

Some characteristic curves are presented next, with the starting torque behavior according to the load types and to recommended control types.

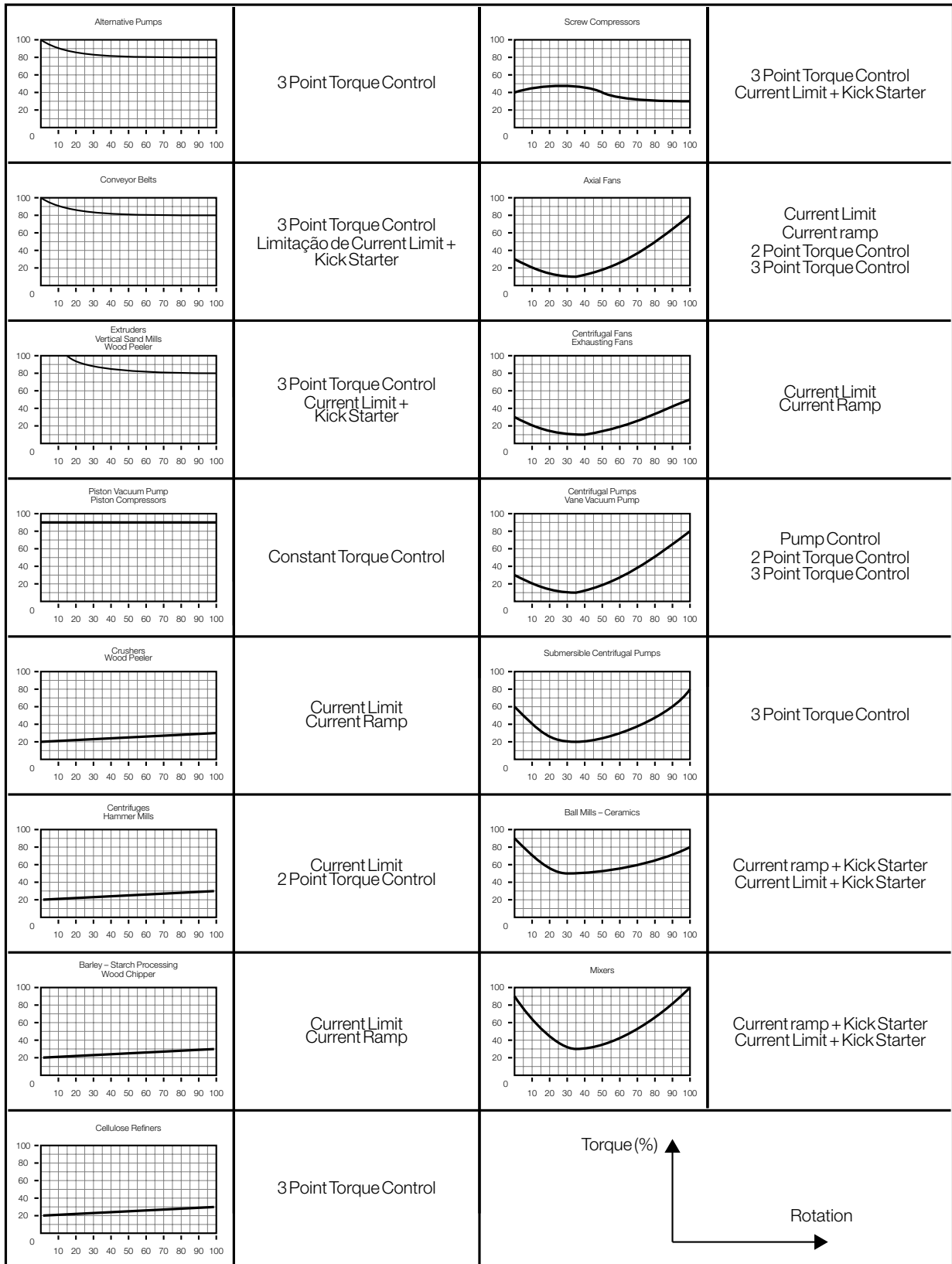

Figure 13.3: Typical starting torque characteristic curves of some loads, with suggested control types.

13.2 STARTING WITH VOLTAGE RAMP + CURRENT LIMIT (C1.1 = 1)

1. Adjust the Initial Voltage (C1.2) initially at a low value.
2. When load is applied to the motor, adjust C1.2 so that the motor begins rotating smoothly at the moment it is started.
3. In C1.3, set the necessary time for starting the motor, initially with short times, 20 to 25 seconds, and later determine the best condition for your load.
4. Program C1.7 with a current limit value allowed by your supply line and that delivers enough torque to start the motor. Initially, it may be set to values between three times to four times the motor rated current (Motor I_n).
5. Parameters related to this example: C1.1 = 1, C1.2, C1.3, C1.4, C1.7, C2.1 e C2.2.

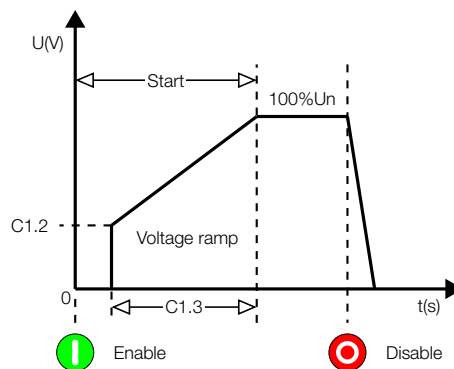

Figure 13.4: Starting with voltage ramp.



NOTE!

1. With long starting times or with no load at the motor, vibrations may occur during the motor starting, therefore, reduce the starting time.
2. The C9.1.1 value must be correct, according to used motor rated current.
3. Too low current limit values do not provide enough torque to start the motor. Make sure the motor begins rotating since the moment it is started.
4. If errors occur while starting, check all the connections from the SSW to the supply line, the motor connections, the supply line voltage levels, the fuses, circuit breakers and disconnect switches.

13.3 STARTING WITH CURRENT LIMIT (C1.1 = 2)

1. For starting with current limit, the load must be coupled to the motor. Tests without load can be performed with voltage ramp;
2. In C1.3, set the necessary time for starting the motor, initially with short times of 25 to 30 seconds. This time will be used as locked rotor time if the motor does not start;
3. Program C1.7 with a current limit value allowed by your supply line and that delivers enough torque to start the motor. It can be initially programmed with values between 3 to 4 times the motor rated current (Motor I_n).
4. Parameters related to this example: C1.1 = 2, C1.3, C1.7, C2.1 e C2.2.

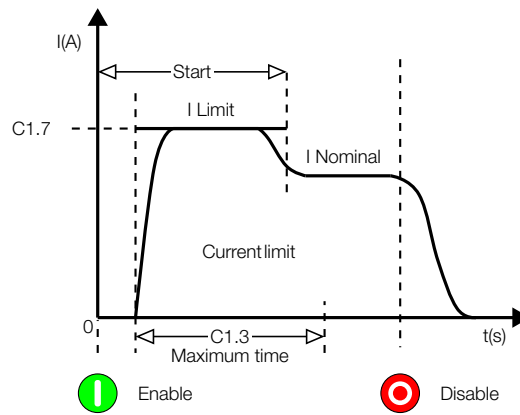

Figure 13.5: Starting with current limit.



NOTE!

1. If the current limit is not reached, the motor accelerates to full speed immediately.
2. The C2.2 value must be correct, according to used motor rated current.
3. Too low current limit values do not provide enough torque to start the motor. Make sure the motor begins rotating since the moment it is started.
4. For loads that require a higher initial starting torque, the kick start function (C7.2), or the current ramp (C1.1 = 3) can be used.
5. If errors occur while starting, check all the connections from the SSW to the supply line, the motor connections, the supply line voltage levels, the fuses, circuit breakers and disconnect switches.

13.4 STARTING WITH CURRENT RAMP AND HIGHER INITIAL VALUE (C1.1 = 3)

1. For starting with current ramp, the load must be coupled to the motor. Tests without load can be performed with voltage ramp.
2. Use this control type for starting loads that require a high initial starting torque, as conveyor belts for instance.
3. By starting this type of load with a fixed current limit, it can be observed that the motor takes some time to start rotating and then accelerates rapidly.
4. The solution would be programming an initial current limit to overcome this resistance and start moving the motor, and then programming a current limit value that keeps the acceleration up to the starting end. Therefore, it is possible to improve the starting smoothness.
5. In C1.5, set the current value necessary to start moving the motor.
6. Adjust C1.6 initially with 10 % of C1.3 (20 s) = 2 s, and later increase it.
7. The motor must start moving as soon as it is started.
8. In C1.7, set the current limit that keeps the motor accelerating.
9. Parameters related to this example: C1.1 = 3, C1.3, C1.5, C1.6, C1.7, C1.12, C2.1 e C2.2.

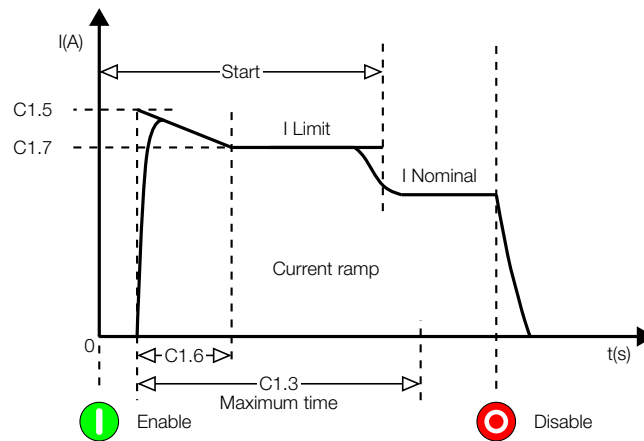

Figure 13.6: Starting with current ramp and higher initial value.



NOTE!

1. If the current limits are not reached, the motor accelerates to full speed immediately.
2. The C2.2 value must be correct, according to used motor rated current.
3. Too low current limit values do not provide enough torque to start the motor. Make sure the motor begins rotating since the moment it is started.
4. If errors occur while starting, check all the connections from the SSW to the supply line, the motor connections, the supply line voltage levels, the fuses, circuit breakers and disconnect switches.

13.5 STARTING WITH CURRENT RAMP AND LOWER INITIAL VALUE (C1.1 = 3)

1. For starting with current ramp, the load must be coupled to the motor. Tests without load can be performed with voltage ramp.
2. Use this control type for starting loads that present a lower initial starting torque, as fans or exhausting fans, or to smoother the initial starting current.
3. By starting this type of load with a fixed current limit, it can be observed that the motor begins the movement accelerating, and then it stops.
4. The solution would be programming a lower initial current limit only to let the motor begin the movement, and then, gradually, increase the current limit until the starting end. Therefore, it is possible to improve the starting smoothness.
5. In C1.5, set the current value necessary just to start moving the motor.
6. Adjust C1.6 initially with 75 % of C1.3 (20 s) = 15 s, and later increase it.
7. The motor must start moving as soon as it is started.
8. In C1.7, set the current limit that keeps the motor accelerating.
9. The motor must remain in acceleration until the end of the start.
10. Parameters related to this example: C1.1 = 3, C1.3, C1.5, C1.6, C1.7, C2.1 e C2.2.

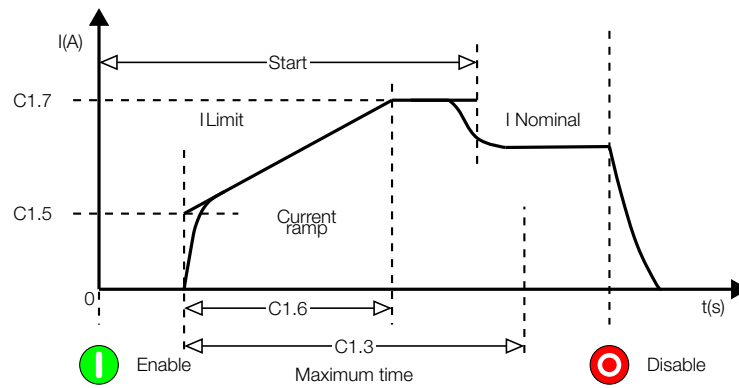

Figure 13.7: Starting with current ramp and lower initial value.



NOTE!

1. If the current limits are not reached, the motor accelerates to full speed immediately.
2. The C2.2 value must be correct, according to used motor rated current.
3. Too low current limit values do not provide enough torque to start the motor. Make sure the motor begins rotating since the moment it is started.
4. If errors occur while starting, check all the connections from the SSW to the supply line, the motor connections, the supply line voltage levels, the fuses, circuit breakers and disconnect switches.

13.6 STARTING WITH PUMP CONTROL (C1.1 = 4)

1. For starting with pump control, the load must be coupled to the motor. Tests without load can be performed with voltage ramp.
2. The starting parameter settings depend very much on the hydraulic installation type, thus, it is always convenient to optimize the factory settings.
3. Verify the correct motor rotation direction, as indicated on the pump frame. If necessary, use the phase sequence protection (C5.5).

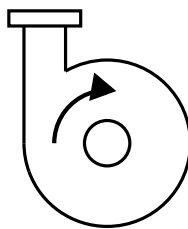

Figure 13.8: Centrifugal hydraulic pump rotation direction.

4. Adjust the Initial Voltage (C1.2) so that the motor begins rotating smoothly at the moment it is started.
5. Adjust an acceleration time (C1.3) long enough for the application, i.e., which allows a smooth pump starting, without exceeding the necessary. Long programmed acceleration times may cause vibrations or unnecessary motor overheating.
6. Always uses a pressure gauge in the hydraulic installation to verify the proper behavior during the motor starting. The pressure increase must not present oscillations and must be as linear as possible.

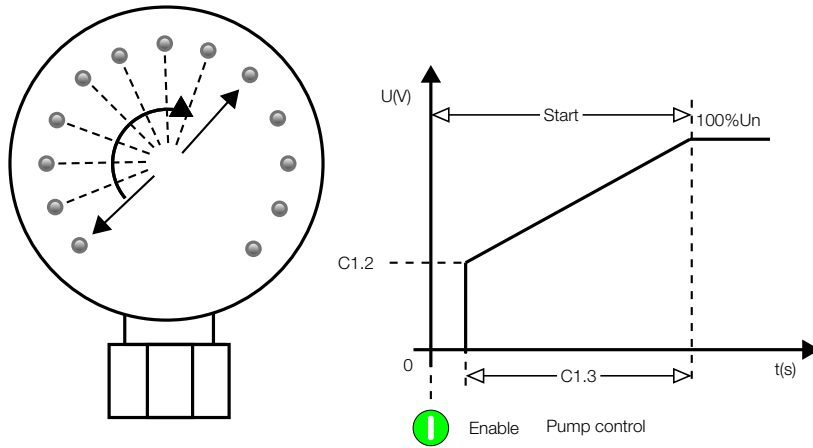

Figure 13.9: Manometer showing the pressure increase.

7. Program the deceleration voltage step (C1.14) only when it is noticed that there is no pressure reduction at the first instant of the deceleration. The deceleration voltage step can improve the pressure decrease linearity.
8. Adjust a deceleration time (C1.13) long enough for the application, i.e., which allows a smooth pump stopping, without exceeding the necessary. Long programmed deceleration times may cause vibrations or unnecessary motor overheating.

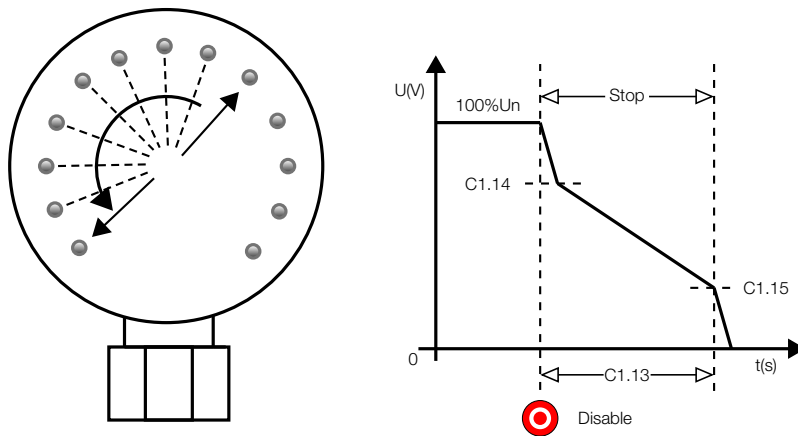

Figure 13.10: Manometer showing the pressure drop.

9. It is common that the current increases at the end of the deceleration time, at this point the motor requires more torque to keep the water flow reducing smoothly. However, if the motor has already stopped and remains enabled, the current will increase considerably, and to avoid this, increase the value of C1.15 up to the ideal value, so that as soon as it stops the motor stops it is disabled.
10. Program C5.2 with current level and time that prevent your hydraulic pump from operating without load.
11. Parameters related to this example: C1.1 = 4, C1.2, C1.3, C1.13, C1.14, C1.15, C2.1, C2.2, C5.2.1, C5.2.2, C5.2.3.

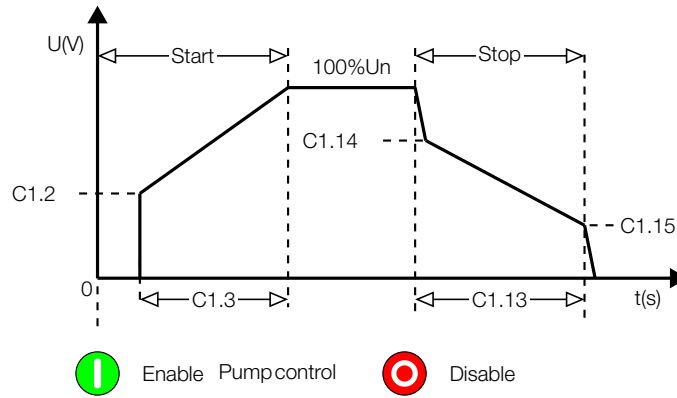

Figure 13.11: Starting with pump control.



NOTE!

1. The C2.1 and C2.2 values must be correct, according to the supply line voltage and to the used motor rated current.
2. If there are no pressure gauges in the piping system, water hammer effects can be observed at the pressure relief valves.
3. Notice that sudden voltage drops in the supply line cause torque reductions in the motor, therefore, keep the supply line characteristics within the allowed limits of your motor.
4. If errors occur while starting, check all the connections from the SSW to the supply line, the motor connections, the supply line voltage levels, the fuses, circuit breakers and disconnect switches.

13.7 STARTING WITH TORQUE CONTROL (C1.1 = 5)

13.7.1 Constant Torque Loads

1. Adjust C1.9 with the percentage of the motor rated torque that is necessary to set the motor+load group in motion.
2. In C1.3, set the necessary time for starting the motor, initially with short times of 25 to 30 seconds.
3. With the torque control it is possible to start the load smoothly and with short starting times, due to the good speed acceleration linearity.
4. Parameters related to this example: C1.1 = 5, C1.3, C1.8 = 1, C1.9, C2.1, C2.2, C2.3, C2.4 e C2.5.

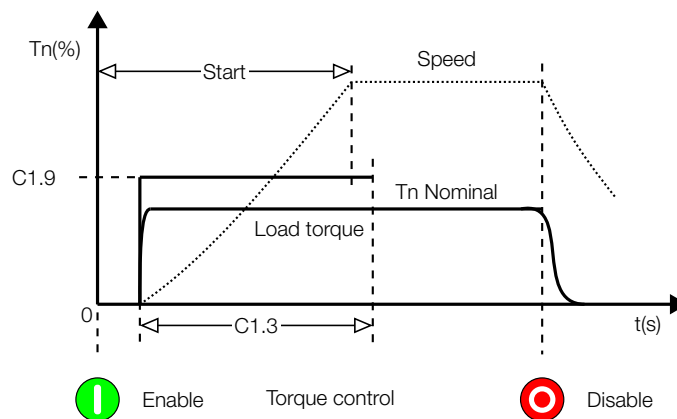

Figure 13.12: Starting with constant torque control - 1 point.

13.7.2 Loads with Higher Initial Torque

1. By using this control type, a very smooth and linear acceleration ramp can be obtained, being it a good solution for starting conveyor belts.
2. With the use of the load curve, the starting torque for each of the C1.9, C1.11 and C1.10 points can be adjusted 10 % to 20 % above the starting torque, and the times in C1.3 and C1.12.
3. An instrument can also be used for measuring the speed during the first start, making sure the desired acceleration or speed curve are met.
4. If there are no load curves available, a method similar to the one described for current ramp can be used. It could also be used the torque limit (C1.8 = 1) for the first starting attempts, and then improve to this control type.
5. Parameters related to this example: C1.1 = 5, C1.3, C1.8 = 3, C1.9, C1.11, C1.10, C1.12, C2.1, C2.2, C2.3, C2.4 e C2.5.

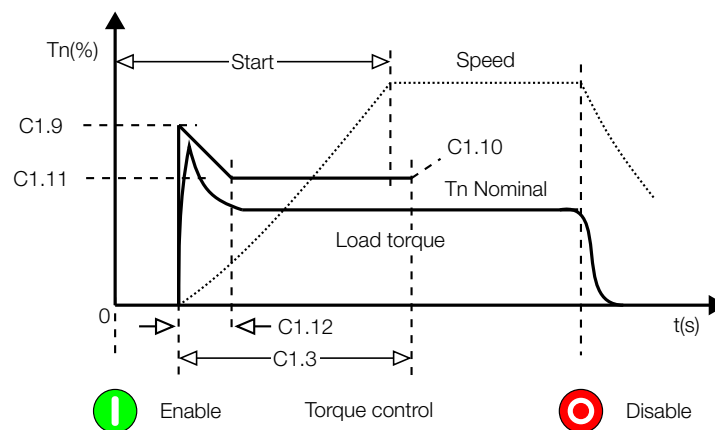

Figure 13.13: Starting with quadratic torque control (3 points) higher initial load.

13.7.3 Constant Torque Loads with S Speed Curve

1. Using the load curve, the torque can be set to 10% to 20% above the load torque for the initial and end points, Initial Starting Torque (C1.9) and End Starting Torque (C1.10), and 30% to 40% above the load torque for the middle point, Minimum Starting Torque (C1.11).
2. Keep C1.12 between 45 % and 55 % and set C1.3 according to the required starting time.
3. An instrument can also be used for measuring the speed during the first start, making sure the desired acceleration or speed curve are met.
4. If there are no load curves available, but there is the certainty that the load torque is constante, the torque limit (C1.8=1) can be used for the first starting attempts, and then improve to this control type.
5. Parameters related to this example: C1.1 = 5, C1.3, C1.8 = 3, C1.9, C1.11, C1.10, C1.12, C1.17, C2.1, C2.2, C2.3, C2.4 e C2.5.

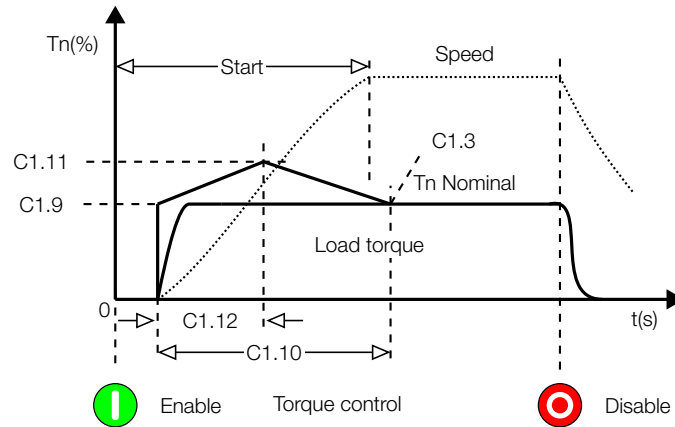

Figure 13.14: Starting with quadratic torque control (3 points) constant load.

13.7.4 Quadratic Torque Loads with S Speed Curve

1. With the linear torque ramp, a speed curve very close to an S curve can be obtained, as long as the quadratic loads are not very accentuated.
2. With the use of the load curve, the initial starting torque, (C1.9), can be adjusted 10 % to 20 % above the load torque, and the end starting torque (C1.10) 20 % to 30 % above the load torque.
3. If there are no load curves available, the next suggestions can be followed:
 - adjust C1.9 with the torque that is necessary to set the motor+load group in motion;
 - adjust C1.10 with 110 % to 130 % of the motor rated torque;
 - initially set short times in C1.3, 10 s to 15 s, and later determine the best value.
4. Parameters related to this example: C1.1 = 5, C1.3, C1.8 = 2, C1.9, C1.10, C2.1, C2.2, C2.3, C2.4 e C2.5.

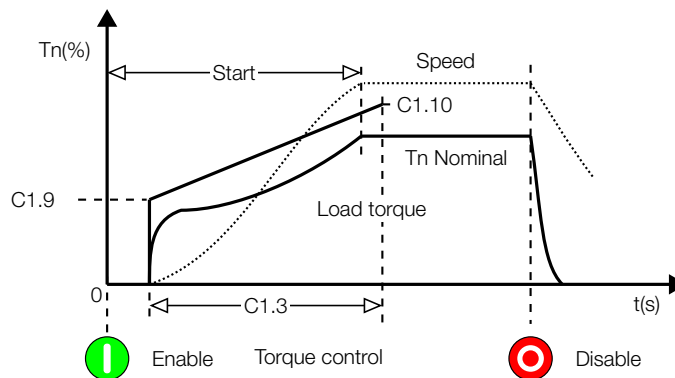

Figure 13.15: Starting with linear torque control (2 points) quadratic load.

13.7.5 Quadratic Torque Loads with Linear Speed Curve

1. With strongly quadratic loads, an intermediate point can be adjusted to improve the starting speed curve linearity.
2. With the use of the load curve, the torque for all the points (C1.9, C1.11 e C1.10) can be adjusted 20 % to 30 % above the load torque, and C1.12 set with the starting time percentage for the intermediate point.
3. If there are no load curves available, program initially linear torque control, C1.8 = 2 points, and later adjust the intermediate torque and time.

4. Parameters related to this example: C1.1 = 5, C1.3, C1.8 = 3, C1.9, C1.11, C1.10, C1.12, C2.1, C2.2, C2.3, C2.4 e C2.5.

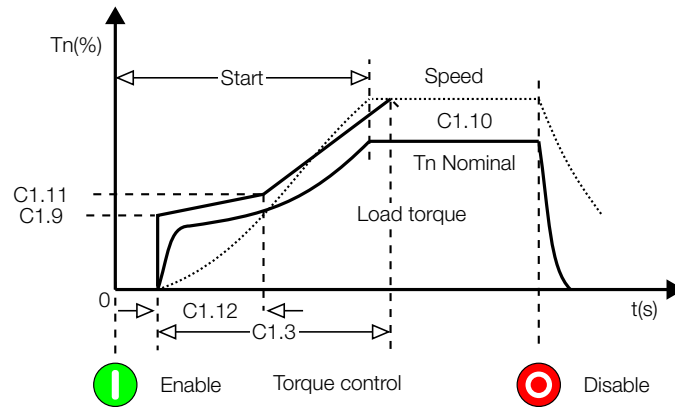

Figure 13.16: Starting with quadratic torque control (3 points) quadratic load.

13.7.6 Quadratic Loads with Higher Initial Torque

1. With very accentuated quadratic loads presenting very high initial torque, an intermediate point can be adjusted to improve the starting speed curve linearity.
2. With the use of the load curve, the torque for all the points (C1.9, C1.11 e C1.10) can be adjusted 20 % to 30 % above the load torque, and C1.12 set with the starting time percentage for the intermediate point.
3. If there are no load curves available, program initially linear torque control, C1.8 = 2 points, and later adjust the intermediate torque and time.
4. Parameters related to this example: C1.1 = 5, C1.3, C1.8 = 3, C1.9, C1.11, C1.10, C1.12, C2.1, C2.2, C2.3, C2.4 e C2.5.

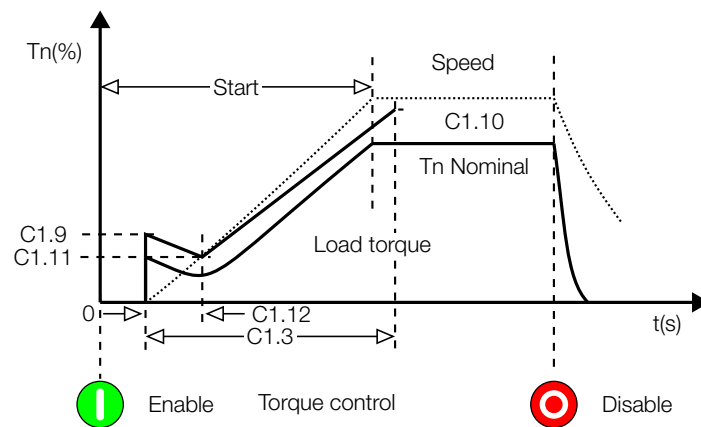

Figure 13.17: Starting with quadratic torque control (3 points) quadratic load with higher initial torque.

13.7.7 Hydraulic Pump Type Loads

Starting (C1.8 = 2 ou C1.8 = 3):

1. First, read the Starting with Pump Control steps.
2. If the pump control does not fulfill your application needs, or if you wish to have a better performance control, use the torque control.

3. With the linear torque ramp and quadratic loads as centrifugal pumps, a speed curve very close to an S curve can be obtained.

4. With the use of the load curve, the initial starting torque (C1.9) can be adjusted 10 % to 20 % above the load torque and the end starting torque (C1.10) 20 % to 30 % above the load torque.

5. Even using the load curve, a fine-tuning at the application is recommended. Suggestions:

- Adjust C1.9 with the torque that is necessary to set the motor+load group in motion;
- Adjust C1.10 with 110 % to 130 % of the motor rated torque;
- Initially set short times in C1.3, 20 s to 25 s, and later determine the best value.

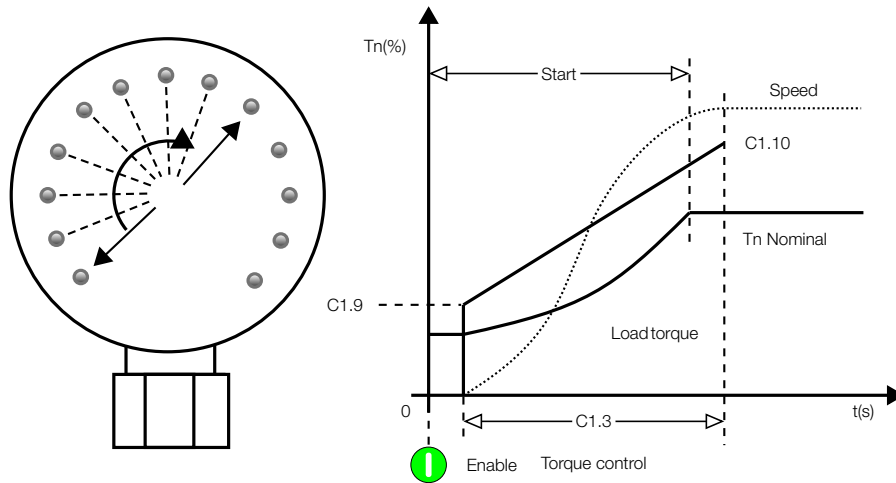

Figure 13.18: Manometer showing pressure rise with linear torque.

6. If the load presents a higher initial torque, use the quadratic torque control (C1.8 = 3).

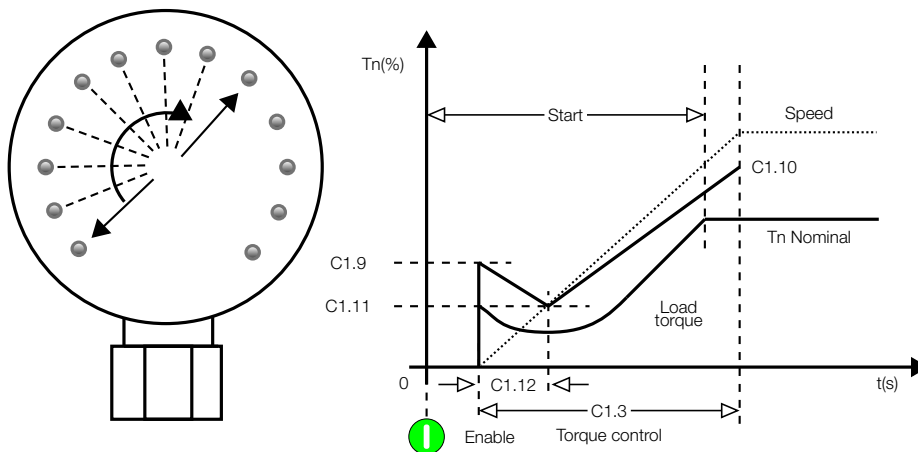

Figure 13.19: Manometer showing pressure rise with quadratic torque.

7. The main objective in both cases is to keep the pressure ramp as linear as possible, increasing gradually and without any type sudden oscillation.

8. As described in the pump control section, a pressure gauge measuring that pressure is always necessary for the optimization of the settings.

9. Parameters related to this example: C1.1 = 5, C1.3, C1.8 = 2 ou 3, C1.9, C1.10, C1.11, C1.12, C2.1, C2.2, C2.3, C2.4 e C2.5.

Stopping (C1.13 ≠ 0 e C1.16 = 1):

1. In most of the applications it is only necessary to use constant torque to stop the pump.
2. This method is applied for not very high water columns.
3. C1.17 can be initially adjusted with the same value as C1.9, if this value is correct.
4. C1.17 must also be adjusted so that when the pump stops the motor does not remain energized for a long period.
5. A gradual pressure decrease must be observed while stopping the pump, without any abrupt oscillation, especially when the retention valve closes at the stopping end.
6. Parameters related to this example: C1.1 = 5, C1.3, C1.8 = 2, C1.9, C1.10, C1.13 ≠ 0, C1.16 = 1, C1.17, C2.1, C2.2, C2.3, C2.4 e C2.5.

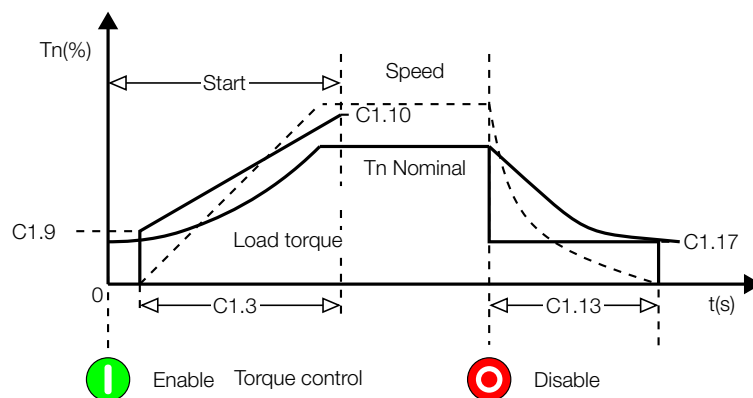

Figure 13.20: Hydraulic pump stopping with constant torque (1 point).

Stopping (C1.13 ≠ 0 e C1.16 = 2):

1. Linear deceleration torque, 2 points = linear.
2. This method is applied for high water columns.
3. C1.17 can be initially adjusted with 10 % to 15 % below the C1.9 value, if this value is correct.
4. Adjust C1.18 so that when beginning the pump stopping, the pressure decreases gradually, without any abrupt oscillation.
5. C1.17 must also be adjusted so that when the pump stops the motor does not remain energized for a long period.
6. Parameters related to this example: C1.1 = 5, C1.3, C1.8 = 2, C1.9, C1.10, C1.13 ≠ 0, C1.16 = 2, C1.17, C1.18, C2.1, C2.2, C2.3, C2.4 e C2.5.

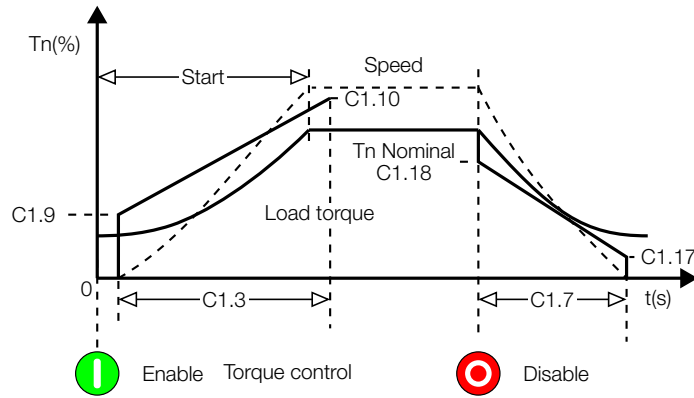

Figure 13.21: Hydraulic pump stopping with linear torque (2 points).

Stopping (C1.13 ≠ 0 ou C1.16 = 3):

1. Quadratic deceleration torque (3 points = quadratic).
2. This method is applied for high pressure water columns.
3. This control is used when it is difficult to keep the pressure decrease gradual, without any type of abrupt oscillation, especially at the beginning of the deceleration.
4. The best way to adjust it is based on the starting curve, setting the 3 points 10 % to 15 % below.
5. C1.19 can be initially set at 50 %.
6. Adjust C1.18 so that when beginning the pump stopping, the pressure decreases gradually, without any abrupt oscillation.
7. C1.17 must also be adjusted so that when the pump stops the motor does not remain energized for a long period.
8. Parameters related to this example: C1.1 = 5, C1.3, C1.8 = 2, C1.9, C1.10, C1.13 ≠ 0, C1.16 = 3, C1.17, C1.18, C1.19, C2.1, C2.2, C2.3, C2.4 e C2.5.

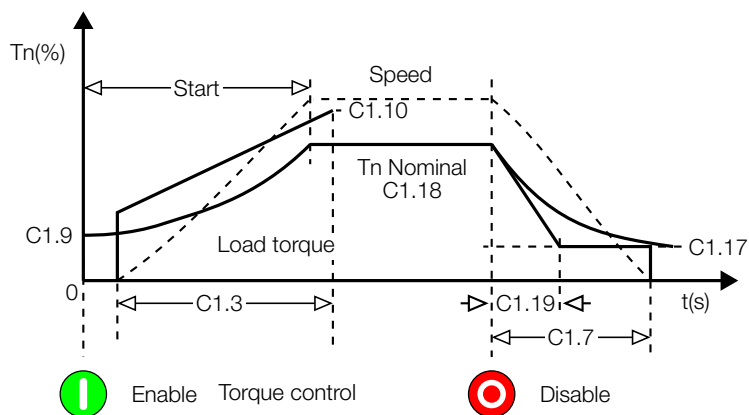

Figure 13.22: Hydraulic pump stopping with quadratic torque (3 points).

9. If the load presents a higher initial torque, use the quadratic torque control C1.8 = 3 points.

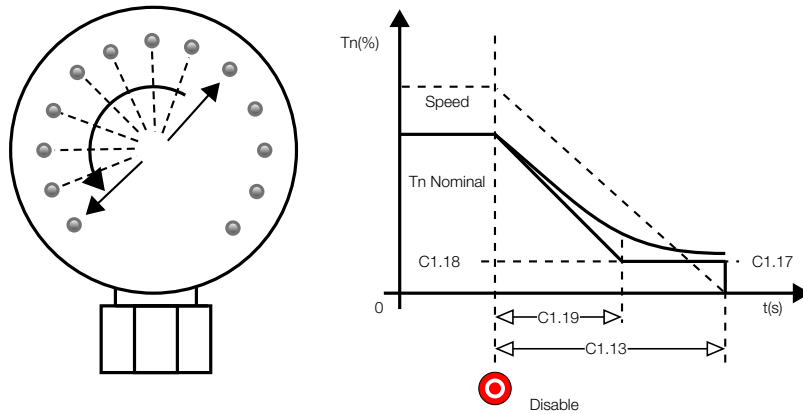

Figure 13.23: Manometer showing pressure fall with torque control.



NOTE!

1. The main objective of the stopping torque control methods is to keep the decrease of the pressure ramp as linear as possible, decreasing gradually and without any abrupt oscillation at the beginning, at the middle, or at deceleration end.
2. As described in the pump control section, a pressure gauge measuring that pressure is always necessary for the optimization of the settings.
3. Notice that the constant torque control works for the majority of the applications, that it is simple and easy to program.

13.8 UNDER AND OVER PROTECTIONS

For the sake of simplicity, all the under- and over- protections of the SSW are adjusted as a percentage of the motor rated values.

13.8.1 Undervoltage and Overvoltage Protections

These functions are normally used for the motor protection.

Initially, the following information is necessary:

1. Motor rated voltage adjusted in C2.1, motor nameplate information;
2. Voltage tolerance withstood by the motor, motor catalog information. It is normally -15 % to +10 % of the rated voltage.

Setting example:

Motor rated voltage of 440V.

Voltage tolerance of -15% a +10%.

Configuration/Nominal Motor Data/Voltage (C2.1) = 440V

Configuration/Protections/Voltage Protection/Motor Undervoltage/Mode (C5.1.1.1) ≠ 0 (Fault or Alarm);

Configuration/Protections/Voltage Protection/Motor Undervoltage/Level (C5.1.1.2) = 15%;

Configuration/Protections/Voltage Protection/Motor Undervoltage/Time (C5.1.1.3) ≠ 0 (3s);

Configuration/Protections/Voltage Protection/Motor Overvoltage/Mode (C5.1.2.1) ≠ 0 (Fault or Alarm);

Configuration/Protections/Voltage Protection/Motor Overvoltage/Level (C5.1.2.2) = 10%;

Configuration/Protections/Voltage Protection/Motor Overvoltage/Time (C5.1.2.3) ≠ 0 (3s);

Therefore, when there is a voltage drop greater than 15 % in the motor supply voltage, regarding its rated voltage, the

undervoltage protection will trip. When there is an increase greater than 10 % in the motor supply voltage, regarding its rated voltage, the overvoltage protection will trip.

13.8.2 Underload Protection

This protection is normally used for detecting dry pump, but it can also be used for the detection of loads beneath the minimum allowed value.

It can be configured, according to the user needs and knowledge, as Undercurrent, Undertorque or Underpower. All these functions present the same form of protection, however, Undertorque and Underpower are more sensitive and detect both current and voltage variations.

Undercurrent setting example:

Motor rated current of 100A.

There is a normal load oscillation of $\pm 10A$ in the motor current in this application.

With no load the current drops to 60A.

As a percentage:

There is a normal load oscillation of $\pm 10\%$ of the motor rated current.

There must be a drop of 40% of the motor rated current, to be considered with no load.

$$\text{Underload (\%)} = \frac{100A - 60A}{100A} \times 100\% = 40\%$$

In order to assure the no load detection, the undercurrent detection must be programmed between 10 % and 40 % (e.g., 30 %).

Configuration/Nominal Motor Data/Current (C2.2) = 100A.

Configuration/Protections/Current Protection/Motor Undercurrent/Mode (C5.2.1.1) $\neq 0$ (Fault or Alarm);

Configuration/Protections/Current Protection/Motor Undercurrent/Level (C5.2.1.2) = 30%;

Configuration/Protections/Current Protection/Motor Undercurrent/Time (C5.2.1.3) $\neq 0$ (3 s);

Therefore, when there is a current drop greater than 30 % in the motor current, regarding its rated current, the protection will trip.

The same sequence demonstrated above is also valid for the Undertorque and Underpower protections, but programming the values and parameters for the respective function.

13.8.3 Overload Protection

It can be configured, according to the user needs and knowledge, as Overcurrent, Overtorque or Overpower. All these functions present the same form of protection, however, Overtorque and Overpower are more sensitive and detect both current and voltage variations.

Overcurrent setting example:

Motor rated current of 100A.

There is a normal load oscillation of $\pm 10A$ in the motor current in this application.

The motor service factor (S.F.) is 1.15.

As a percentage:

There is a normal load oscillation of $\pm 10\%$ of the motor rated current.

The motor is able to withstand a 15% overload, according to the service factor, S.F..

$$\text{Overcurrent (\%)} = \frac{115A - 100A}{100A} \times 100\% = 15\%$$

In order to detect a heavy load, the overcurrent protection can be programmed above 15%. For example 20%.
 Configuration/Nominal Motor Data/Current (C2.2) = 100A

Configuration/Protections/Current Protection/Motor Overcurrent/Mode (C5.2.2.1) ≠ 0 (Fault ou Alarm);
 Configuration/Protections/Current Protection/Motor Overcurrent/Level (C5.2.2.2) = 20%;
 Configuration/Protections/Current Protection/Motor Overcurrent/Time (C5.2.2.3) ≠ 0 (3 s);

Therefore, when there is a current increase greater than 20 % of the motor current, regarding is rated current, the protection will trip.

The same sequence demonstrated above is also valid for the Overtorque and Overpower protections, but programming the values and parameters for the respective function.

13.9 THERMAL CLASSES

Suggestions on how to set thermal class for factory setting (C5.9.1 = 0) mode are described next.

13.9.1 How to choose the thermal class

- 1) Initially start the motor some times in the standard thermal class (class 30), but without heating it up excessively;
- 2) Obtain the average starting current and the correct starting time.
 Motor starting data are available in the diagnostics menu.
 - Starting current/Medium (D4.1.2)
 - Real starting time/Final (D4.2.2)

For example:

When an 80A motor is started by voltage ramp.
 starts at 100A and increases to 300A and after 20s decreases to the nominal current.

- Starting current/Medium (D4.1.2) = 200A
- Real starting time/Final (D4.2.2) = 20s

$200A/80A = 2,5 \times I_n$ of the motor
 then: $2,5 \times I_n @ 20s$.

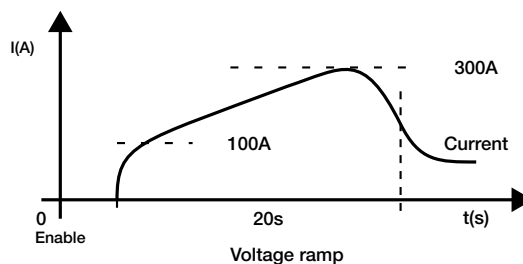

Figure 13.24: Typical current curve when started by voltage ramp.

- 3) Use this time to find the minimum class necessary to start a cold motor according to the descriptions of C5.9 in chapter 11, figure 11.22.

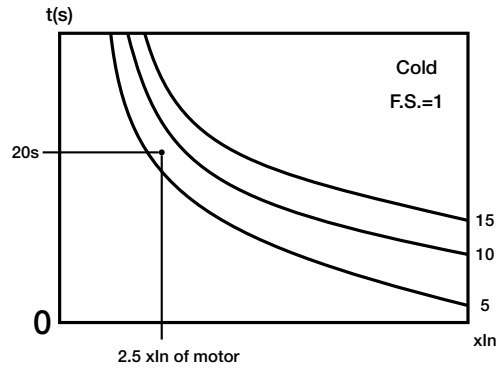

Figure 13.25: Determining the minimum thermal class with cold motor.

Thus the minimum required thermal class for starting the motor is the Class 10. The Class 5 requires a shorter time for this current. This Thermal Class allows motor cold start.

4) To determine the thermal class for starting at hot motor, the motor thermal class must be known. For this we must determine the allowed locked rotor time (hrlt) and starting current (I_p/I_n) of the motor.

NOTE! To program the Thermal Class that your motor will withstand, the allowed locked rotor time (hrlt) must be available. For this data, please refer to the manufacturer catalog.

With the locked rotor time (hrlt) and stating current (I_p/I_n) of the motor, we can find the maximum thermal class that will protect the motor for hot starting, according to the descriptions in chapter 11, figure 11.22.

For example:
6,6 x I_n @ 6s

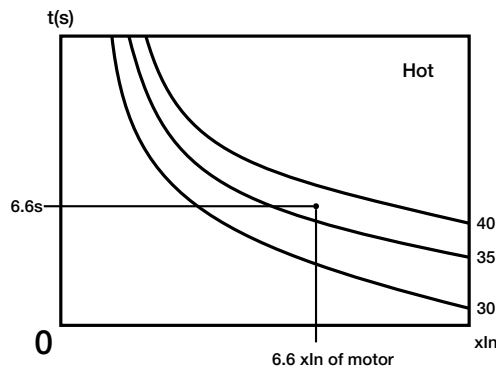

Figure 13.26: Determining the maximum thermal classes through the hot starting curves.

Thus, the maximum thermal class that will protect the motor is Class 35, Class 40 has too long time for this current. This thermal class allows the motor to start at hot motor, in other words, it can be started in any condition.

NOTE! Please consider that this protection adopts WEG standard three-phase IP55 motor as a standard. Thus, if your motor is different, do not program the maximum allowed thermal class, but program the thermal class near the minimum thermal class required for the start.

13.9.2 Example of how to program the Thermal Class

Motor data:
Power: 50cv

Voltage: 380V
 Nominal current (In): 71A
 Service factor (F.S.): 1,00
 Starting current (Ip/In) : 6,6
 locked rotor time (hrlt): 12s
 RPM: 1770

Data about the motor + load Starting:
 Starting by Voltage Ramp, average starting current:
 3 x the nominal motor current during 25s (3 x In @ 25s).

1) In the chart, at hot, we can find the maximum Thermal that the motor will withstand:

- hot locked rotor time (hrlt) = 12s
- starting current (Ip/In) = 6,6x

For 6,6 x In @ 12s, we select the closest lower Class: Class 40.

1) In the chart, at cold, we can find the minimum required thermal class that allows motor start with reduced voltage:

- Starting current/Medium (D4.1.2) = 213A
- Real starting time/Final (D4.2.2) = 25s

For 3 x In @ 25s, we select the closest higher one: Class 10.

Now it is known that Thermal Class 10 allows one cold starting and Thermal Class 40 is the upper limit.

Thus you must select a Thermal Class between these two Thermal Classes by considering the number of starts per hour and the time interval between motor Off-On procedures.

The closer to Class 10 you select, more protected will be your motor, less starts per hour are allowed and longer time intervals between motor Off-On procedures are required.

The closer to Class 40 you select, you will be nearer the upper motor limit, thus more starts per hour are allowed and shorter time intervals between motor Off-On procedures can be used.

We have chosen the thermal class 30. If improper actuation of the protection occurs, we know we can still set above.

13.9.3 Time Reduction When Changing from Cold Starting to Hot Starting

The times of the cold thermal class curves are based on one start with the motor at ambient temperature.

The times of the hot thermal class curves consider the motor running at nominal conditions long enough to reach the full operating temperature.

Therefore, the difference between both is automatically controlled by the motor thermal image, which simulates the motor heating and cooling based on the current.

As well as when the motor current at full voltage is below the rated current. The times are also automatically adjusted by the motor thermal image, thus providing more time for the new motor start.

13.9.4 Service Factor

When the Service factor (S.F.) is different from 1.00, but its use is required, you can find in the chart, at cold, the points for the S.F. = 1.15 and a table for S.F. = 1.15.

If you want to know the thermal protection activation time for other Service Factor (S.F.), displace the line xIn proportionally to the left.

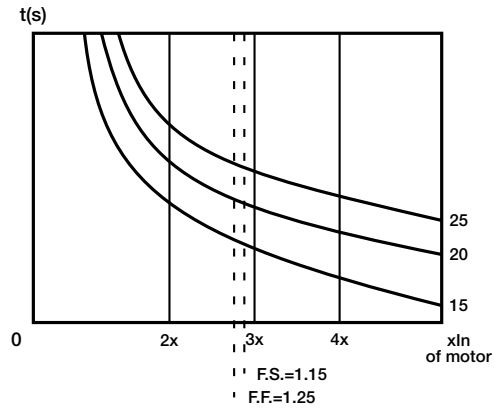

Figure 13.27: Using the S.F. to find new times.



WEG Drives & Controls - Automação LTDA.
Jaraguá do Sul – SC – Brazil
Phone 55 (47) 3276-4000 – Fax 55 (47) 3276-4020
São Paulo – SP – Brazil
Phone 55 (11) 5053-2300 – Fax 55 (11) 5052-4212
automacao@weg.net
www.weg.net